



Parcel Map Review Committee Staff Report

Meeting Date: February 8, 2018

Agenda Item: 7B

TENTATIVE PARCEL MAP CASE NUMBER: WTPM17-0011 (Pardula Living Trust)

BRIEF SUMMARY OF REQUEST: To approve a parcel map dividing one parcel of ±9.01 acres into three parcels of ±1.215 acres, ±6.07 acres and 1.722 acres in size.

STAFF PLANNER:	Planner's Name:	Julee Olander
	Phone Number:	775.328.3627
	E-mail:	jolander@washoecounty.us

CASE DESCRIPTION

For possible action, hearing, and discussion by the Washoe County Parcel Map Review Committee to approve a tentative parcel map dividing one parcel of ±9.01 acres into three parcels. The three parcels will be ±52,933 square feet (1.215 acres), ±6.07 acres and ±75,022 square feet (1.722 acres) in size. Located on Timberline Drive approximately 0.4 miles north of Mt. Rose Highway

Applicant/Property Owner:	Todd & Manuela Pardula
Location:	Timberline Drive, approximately 0.4 miles north of Mt. Rose Highway
APN:	049-060-57
Parcel Size:	±9.01 acres
Master Plan:	Suburban Rural (SR) & Rural (R)
Regulatory Zone:	Low Density Suburban (LDS) & General Rural (GR)
Area Plan:	Forest
Citizen Advisory Board:	South Truckee Meadows/Washoe Valley
Development Code:	Authorized in Article 606, Parcel Maps
Commission District:	1 - Berkbigler
Section/Township/Range:	NW ¼ of Section 34, T18N, R19E, MDM, Washoe County, NV

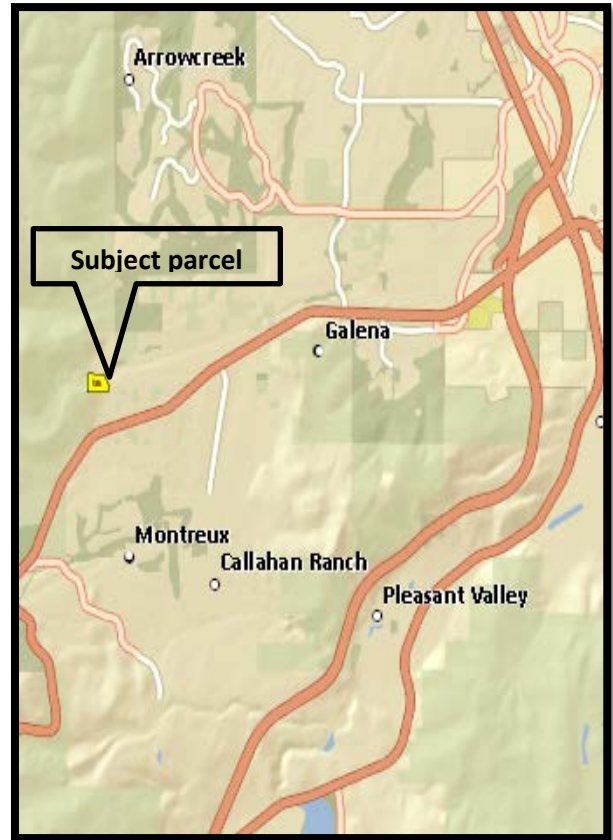

STAFF RECOMMENDATION

APPROVE

APPROVE WITH CONDITIONS

DENY

POSSIBLE MOTION

I move that, after giving reasoned consideration to the information contained within the staff report and the information received during the public meeting, that the Washoe County Parcel Map Review Committee approve Parcel Map Case Number WTPM17-0011 for Pardula Living Trust, subject to the conditions of approval included as Exhibit A with the staff report, and make the determination that the following criteria is or will be adequately provided for pursuant to Washoe County Code, Section 110.606.30.

(Motion with Findings on Page 9)

Staff Report Contents

Site Plan..... 3
Forest Area Plan Modifiers 7
Development Information 7
Reviewing Agencies 7
Staff Comment on Required Findings..... 8
Possible Motion 9
Appeal Process10

Exhibit Contents

Conditions of ApprovalExhibit A
Agency Review CommentsExhibit B
Project Application.....Exhibit C

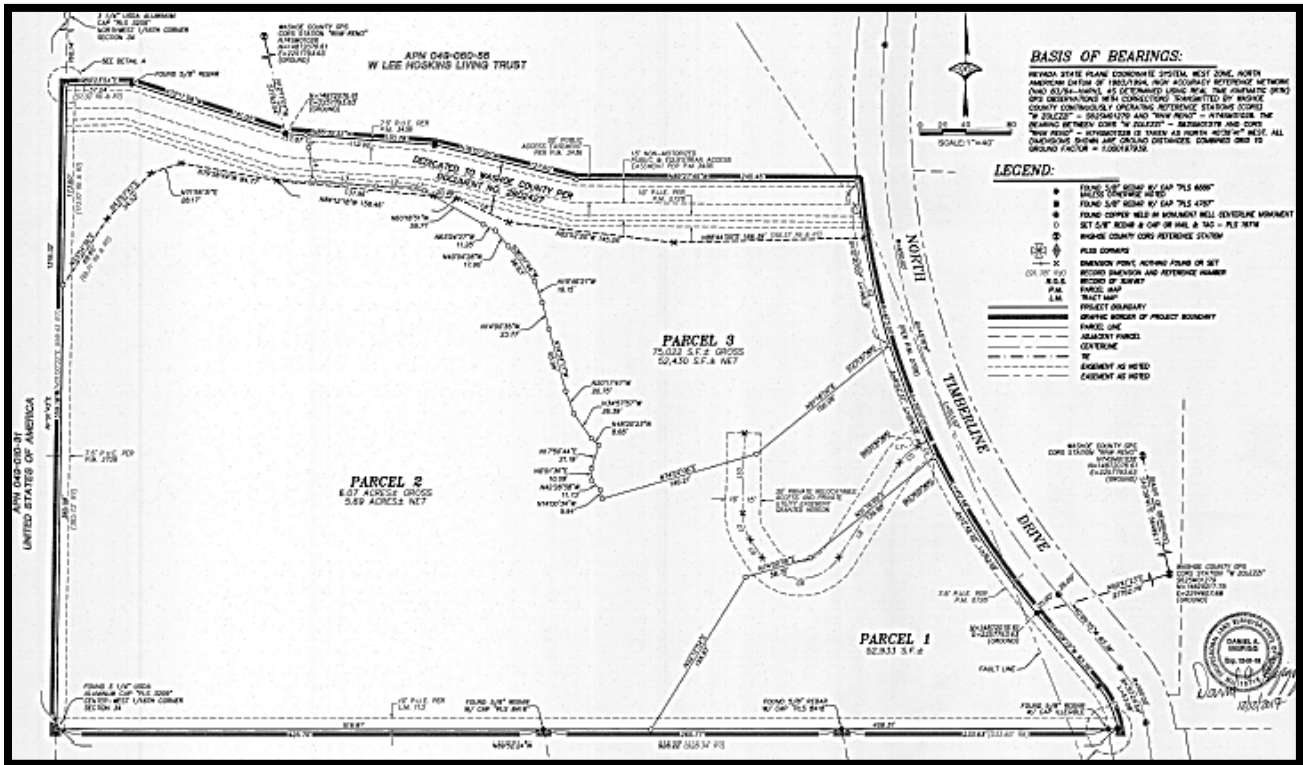
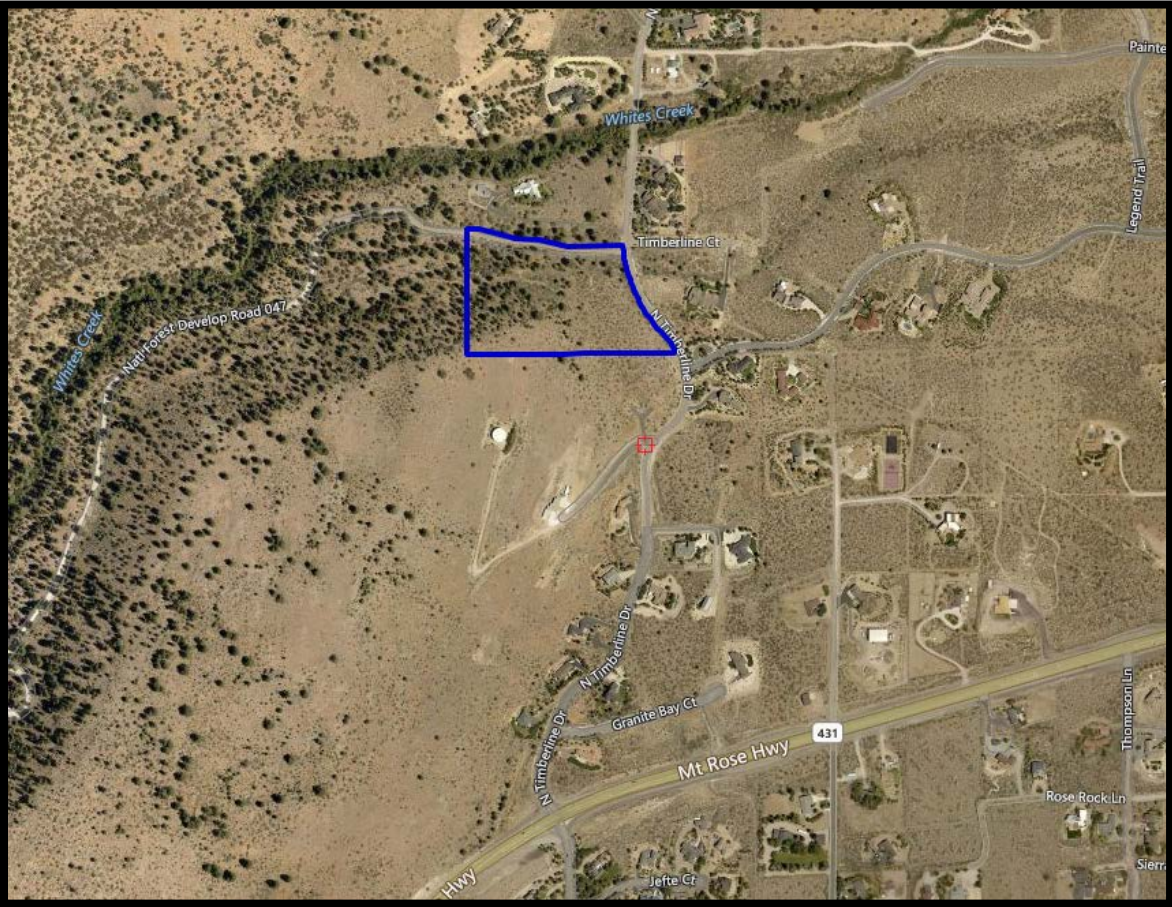

Site Plan

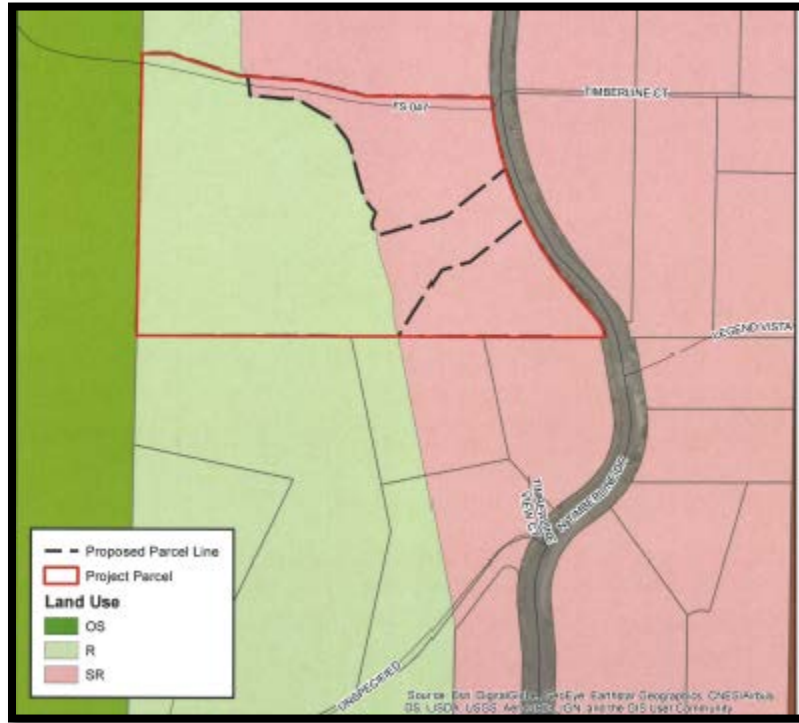

Land Use Map

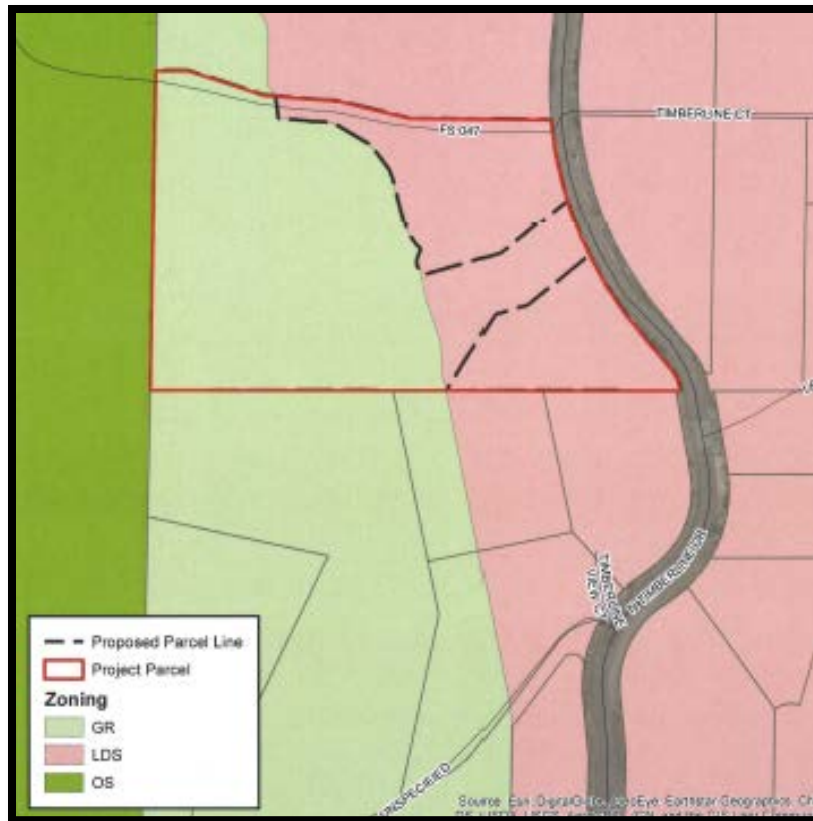

Zoning Map

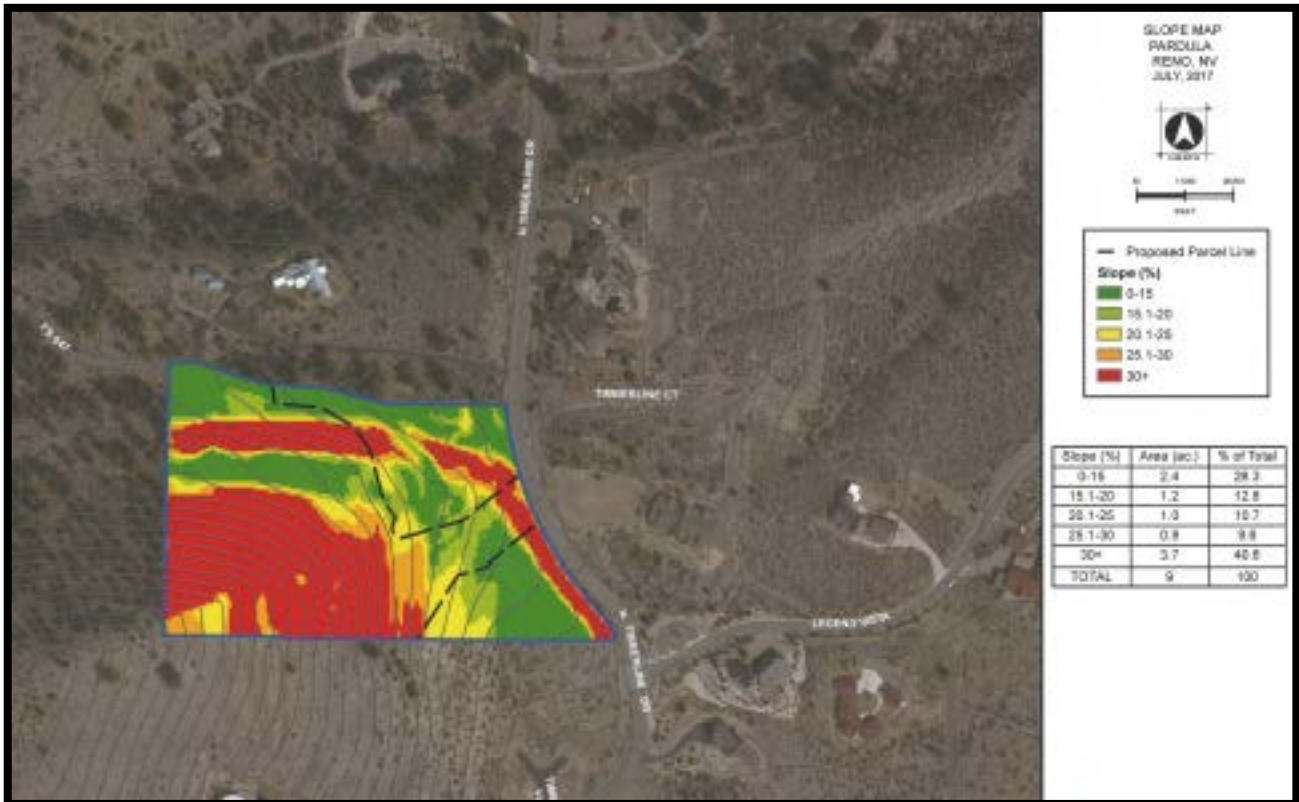

Slope Map



View from Timberline Drive



View from Forest Service Road

Tentative Parcel Map Evaluation

Land Use Designation:	Low Density Suburban (LDS) & General Rural (GR)
Maximum Lot Potential:	3 lots
Number of Lots on Parcel Map:	3 lots
Minimum Lot Size Required:	35,000 square feet
Minimum Lot Size on Parcel Map:	52,933 square feet
Minimum Lot Width Required:	120 feet
Minimum Lot Width on Parcel Map:	over 120 feet

The tentative parcel map meets all minimum requirements for the Low Density Suburban (LDS) regulatory zone.

Development Suitability Constraints: The Forest Area Plan Development Suitability Map, a part of the Forest Area Plan, identifies the subject parcel as having slopes greater than 15 % and slopes greater than 30%

Hydrographic Basin: The subject parcel is within the Pleasant Valley Hydrographic Basin.

The subject parcel is inside the Truckee Meadows Service Area (TMSA).

Forest Area Plan Modifiers

There are no modifiers within Article 204 (Area Plan Regulations – Forest Area) of the Washoe County Code Chapter 110 (Development Code) that effect the evaluation of this proposed parcel map.

Development Information

The subject site is undeveloped at this time, with the exception of US Forest Service road 047 on the north side of the property which is paved and accesses the Whites Creek trailhead. The road has been dedicated to Washoe County and there is 20-foot public easement for the roadway and also for a 15-foot non-motorized public and equestrian easement (See Site Plan on page 3). The vacant subject site does appear to have slopes greater than 30% site (See Slope Map on page 5). The three parcels will have regulatory zoning LDS and LDS setbacks are 30 feet in the front and rear and 12 feet on the side. There is sufficient area within each proposed parcel to meet these standards.

Reviewing Agencies

The following agencies received a copy of the project application for review and evaluation.

- Washoe County Community Services Department
 - Planning and Building Division
 - Engineering and Capital Projects Division
 - Parks and Open Spaces
 - Washoe County Water Management Coordinator
- Washoe County Health District
 - Environmental Health Services Division
- Truckee Meadows Fire Protection District
- Regional Transportation Commission (RTC)
- Washoe-Storey Conservation District

3 out of the 7 above listed agencies/departments provided comments and/or recommended conditions of approval in response to their evaluation of the project application. A summary of each agency's comments and/or recommended conditions of approval and their contact information is provided. The Conditions of Approval document is attached to this staff report and will be included with the Action Order if granted approval.

- **Washoe County Planning and Building Division- Planning** requires the final map be in substantial compliance with all plans and documents submitted with the tentative parcel map.
Contact: Julee Olander, 775.328-3627, jolander@washoecounty.us
- **Washoe County Planning and Building Division- Water Planning** provided comments related to water service.
Contact: Vahid Behmaram, 775.945.4647, vbehmaram@washoecounty.us
- **Washoe County Engineering and Capital Projects Division** provided comments related to sewer, utilities, and access/easement.
**Contact: Tim Simpson, 775.954.4648, tsimpson@washoecounty.us
Mike Gump, 775.328.2315, mgump@washoecounty.us**

The Washoe County Health District, Truckee Meadows Fire Protection District and Regional Transportation Commission reviewed the application and indicated they had no comments or conditions of approval.

Staff Comment on Required Findings

Washoe County Code Section WCC Section 110.606.30 (i) requires that all of the following findings be made to the satisfaction of the Washoe County Parcel Map Review Committee before granting approval of the request. Staff has completed an analysis of the application and has determined that the proposal is in compliance with the required findings as follows.

- 1) General improvement considerations for all parcel maps including, but not limited to:
 - a) Environmental and health laws and regulations concerning water and air pollution, the disposal of solid waste, facilities to supply water, community or public sewage disposal and, where applicable, individual systems for sewage disposal.
Staff Comment: Compliance with all applicable environmental and health laws and regulations concerning water and air pollution, the disposal of solid waste, facilities to supply water, and sewage disposal will be ensured prior to recordation of the final map or prior to approval of a development permit on the subject site. The application was reviewed by the appropriate agencies and no recommendation for denial was received.
 - b) The availability of water which meets applicable health standards and is sufficient for the reasonably foreseeable needs of the subdivision.
Staff Comment: The existing and proposed lots will be served by community water and sewer services, provided by the Truckee Meadows Water Authority and Washoe County. The application was reviewed by the appropriate agencies and no recommendation for denial was received.
 - c) The availability and accessibility of utilities.
Staff Comment: The existing and proposed lots will be served by extension of the existing, adjacent, infrastructure to serve the newly created parcel.
 - d) The availability and accessibility of public services such as schools, police and fire protection, transportation, recreation and parks.
Staff Comment: The proposed parcel map would create two additional lots within a previously developed area that is currently served by community services. The application was reviewed by the appropriate agencies and no recommendation for denial was received.
 - e) Conformity with the zoning ordinances and master plan.
Staff Comment: The proposed division of land is in conformity with the existing Low Density Suburban Regulatory Zone and the applicable provisions of the Washoe County Development Code and Master Plan.
 - f) General conformity with the governing body's master plan of streets and highways.
Staff Comment: The application was reviewed by the appropriate agencies and no recommendation for denial was received, the proposal is in conformance with the Area Plan and Master plans for streets and highways.
 - g) The effect of the proposed subdivision on existing public streets and the need for new streets or highways to serve the subdivision.
Staff Comment: The application was reviewed by the appropriate agencies, including Washoe County Engineering and Capital Projects Division, and no recommendation for denial was received, no recommendation for new streets or highways to serve the subdivision was received.

- h) Physical characteristics of the land such as floodplain, slope and soil.

Staff Comment: The application was reviewed by the appropriate agencies, including Washoe County Engineering and Capital Projects Division, and no recommendation for denial was received.

- i) The recommendations and comments of those entities reviewing the tentative parcel map pursuant to NRS 278.330 and 278.348, inclusive.

Staff Comment: All recommended conditions of approval have been included with the staff report. These sections of Nevada Revised Statutes deal with technical review of the map, review appropriate agencies for health considerations, and utility considerations.

- j) The availability and accessibility of fire protection including, but not limited to, the availability and accessibility of water and services for the prevention and containment of fires including fires in wild lands.

Staff Comment: The application was reviewed by the appropriate agencies, including the Truckee Meadows Fire Protection District, and no recommendation for denial was received.

- k) Community antenna television (CATV) conduit and pull wire.

Staff Comment: The application was reviewed by the appropriate agencies and no recommendation for denial was received. All appropriate easements shall be provided prior to approval of the final map.

- l) Recreation and trail easements.

Staff Comment: The application was reviewed by the appropriate agencies and no recommendation for denial was received.

Recommendation

Those agencies which reviewed the application recommended conditions in support of approval of the project. Therefore, after a thorough analysis and review, Tentative Parcel Map Case Number WTPM17-0011 is being recommended for approval with conditions. Staff offers the following motion for the Parcel Map Review Committee's consideration.

Possible Motion

I move that, after giving reasoned consideration to the information contained in the staff report and information received during the public hearing, the Washoe County Parcel Map Review Committee approve Parcel Map Case Number WTPM17-0011 for Pardula Living Trust, subject to the conditions of approval included as Exhibit A with the staff report, and make the determination that the following criteria is or will be adequately provided for pursuant to Washoe County Code Section 110.606.30:

- 1) General improvement considerations for all parcel maps including, but not limited to:
 - a) Environmental and health laws and regulations concerning water and air pollution, the disposal of solid waste, facilities to supply water, community or public sewage disposal and, where applicable, individual systems for sewage disposal;
 - b) The availability of water which meets applicable health standards and is sufficient for the reasonably foreseeable needs of the subdivision;
 - c) The availability and accessibility of utilities;
 - d) The availability and accessibility of public services such as schools, police and fire protection, transportation, recreation and parks;
 - e) Conformity with the zoning ordinances and master plan;

- f) General conformity with the governing body’s master plan of streets and highways;
- g) The effect of the proposed subdivision on existing public streets and the need for new streets or highways to serve the subdivision;
- h) Physical characteristics of the land such as floodplain, slope and soil;
- i) The recommendations and comments of those entities reviewing the tentative parcel map pursuant to NRS 278.330 and 278.348, inclusive;
- j) The availability and accessibility of fire protection including, but not limited to, the availability and accessibility of water and services for the prevention and containment of fires including fires in wild lands;
- k) Community antenna television (CATV) conduit and pull wire; and
- l) Recreation and trail easements.

Appeal Process

Parcel Map Review Committee action will be effective 10 calendar days after the written decision is filed with the Secretary to the Parcel Map Review Committee, unless the action is appealed to the Washoe County Board of Commissioners, in which case the outcome of the appeal shall be determined by that Board. Any appeal must be filed in writing within 10 calendar days from the date the written decision is filed with and signed by the Secretary of the Parcel Map Review Committee and mailed to the applicant.

Applicant/Owner Todd & Manuela Pardula

Representative: Wood Rodgers, Inc.
1361 Corporate Boulevard
Reno. NV 89502

Action Order xc: Nathan Edwards, District Attorney’s Office; Keirsten Beck, Assessor’s Office;
Cori Burke, Assessor’s Office; Tim Simpson, Utilities; Leo Vesely,
Engineering and Capital Projects; Denise Reynolds, Truckee Meadows Fire
Protection District; South Truckee Meadows/Washoe Valley Citizen Advisory
Board, Chair



Conditions of Approval

Tentative Parcel Map Case Number WTPM17-0011

The tentative parcel map approved under Tentative Parcel Map Case Number WTPM17-0011 shall be carried out in accordance with the Conditions of Approval granted by the Washoe County Parcel Map Review Committee on February 8, 2018. Conditions of Approval are requirements placed on a permit or development by each reviewing agency. These Conditions of Approval may require submittal of documents, applications, fees, inspections, amendments to plans, and more. These conditions do not relieve the applicant of the obligation to obtain any other approvals and licenses from relevant authorities required under any other act or to abide by all other generally applicable Codes, and neither these conditions nor the approval by the County of this project/use override or negate any other applicable restrictions on uses or development on the property.

Unless otherwise specified, all conditions related to the approval of this tentative parcel map shall be met or financial assurance must be provided to satisfy the conditions of approval prior to the recordation of a final parcel map. The agency responsible for determining compliance with a specific condition shall determine whether the condition must be fully completed or whether the applicant shall be offered the option of providing financial assurance. All agreements, easements, or other documentation required by these conditions shall have a copy filed with the County Engineer and the Planning and Building Division.

Compliance with the conditions of approval related to this tentative parcel map is the responsibility of the applicant, his/her successor in interest, and all owners, assignees, and occupants of the property and their successors in interest. Failure to comply with any of the conditions imposed in the approval of the tentative parcel map may result in the institution of revocation procedures.

Washoe County reserves the right to review and revise the Conditions of Approval related to this tentative parcel map should it be determined that a subsequent license or permit issued by Washoe County violates the intent of this approval.

For the purpose of conditions imposed by Washoe County, “may” is permissive and “shall” or “must” is mandatory.

Conditions of Approval are usually complied with at different stages of the proposed project. Those stages are typically:

- Prior to recordation of a final map.
- Prior to obtaining a final inspection and/or a certificate of occupancy.
- Prior to the issuance of a business license or other permits/licenses.
- Some “Conditions of Approval” are referred to as “Operational Conditions.” These conditions must be continually complied with for the life of the project.

FOLLOWING ARE CONDITIONS OF APPROVAL REQUIRED BY THE REVIEWING AGENCIES. EACH CONDITION MUST BE MET TO THE SATISFACTION OF THE ISSUING AGENCY.

Washoe County Planning and Building Division

1. The following conditions are requirements of the Planning and Building Division, which shall be responsible for determining compliance with these conditions.

Contact: Julee Olander, Planner, 775.328.3627, jolander@washoecounty.us

- a. The final map shall be in substantial compliance with all plans and documents submitted as part of this tentative parcel map application, and with any amendments imposed by the Parcel Map Review Committee. All documentation necessary to satisfy the conditions noted below shall accompany the final map when submitted to the County Engineer and the Planning and Building Division.
- b. The applicant shall comply with all the conditions of approval and shall submit a final map for signature by the Director of the Planning and Building Division within 22 months from the date of approval by the Parcel Map Review Committee. Each agency responsible for imposing conditions may determine whether its conditions must be fully completed or whether the applicant shall be offered the option of providing financial assurances as a means of assuring compliance.
- c. The final map shall contain the following jurat:

DIRECTOR OF PLANNING AND BUILDING CERTIFICATE

THE FINAL PARCEL MAP CASE NO. WTPM17-0011 MEETS ALL APPLICABLE STATUTES, ORDINANCES AND CODE PROVISIONS; IS IN SUBSTANTIAL CONFORMANCE WITH THE TENTATIVE MAP AND ITS CONDITIONS, WHICH ARE INCORPORATED HEREIN BY THIS REFERENCE, AND THOSE CONDITIONS HAVE BEEN SATISFIED FOR RECORDATION OF THIS MAP. THE OFFER(S) OF DEDICATION IS (ARE) REJECTED AT THIS TIME, BUT WILL REMAIN OPEN IN ACCORDANCE WITH NEVADA REVISED STATUTES CHAPTER 278.

THIS FINAL MAP IS APPROVED AND ACCEPTED THIS _____ DAY OF _____, 20_____, BY THE DIRECTOR OF THE PLANNING AND BUILDING DIVISION OF WASHOE COUNTY, NEVADA, IN ACCORDANCE WITH NEVADA REVISED STATUTES 278.471 THROUGH 278.4725.

MOJRA HAUENSTEIN, DIRECTOR, PLANNING AND BUILDING DIVISION

- d. The applicant has indicated that the proposed improvements will not exceed the major grading thresholds that require a special use permit. If the final construction drawings for the map include grading that exceeds the *Major Grading Permit Thresholds* listed in Article 438 Grading Standards, the applicant shall apply for a special use permit for grading; and if approved, may be delayed up to three months processing time. In addition, all related standards within the Washoe County Development Code shall be met on the construction drawings. Compliance shall be determined by the Planning and Building Division.
- e. The approval for this tentative parcel map does not include improvements for driveways to building pads. Grading for access to building pads, if they exceed the criteria stated in the previous condition, shall require a special use permit. Compliance shall be determined by the Planning and Building Division.

Washoe County Engineering and Capital Projects Division- Utility

2. The following conditions are requirements of the Engineering and Capital Projects Division, which shall be responsible for determining compliance with these conditions.

Contact: Tim Simpson, 775.954.4648, tsimpson@washoecounty.us

- a. The applicant shall either dedicate an easements for the purpose of allowing parcel two (2) to construct, reconstruct, alter, repair, maintain a sanitary sewer lateral through parcel three (3), or shall have one of the laterals located on the future parcel three (3) abandoned to the satisfaction of Washoe County's Sewer Utility.

Washoe County Engineering and Capital Projects Division

3. The following conditions are requirements of the Engineering and Capital Projects Division, which shall be responsible for determining compliance with these conditions.

Contact: Mike Gump, 775.954.4648, mgump@washoecounty.us

- a. Comply with the conditions of the Washoe County technical check for this map.
- b. The applicant shall submit a letter from a PLS certifying that the driveway improvements do not exceed a 14% gradient.
- c. The proposed access roadway to the parcels traverse slopes 30% or greater and per Washoe County Code requires a Special Use Permit (Article 110.438.35.a.3). Prior to the recordation of the final map a Special Use Permit shall be obtained for the proposed access road or any driveway which traverses slopes 30% or greater.
- d. Prior to the recordation of the final map, the access roadway shall be designed and submitted for review and approval by Washoe County and constructed. An asphalt or concrete driveway apron in accordance with Washoe County standard detail W5.2 or W5.3 shall be provided at the tie-in with Timberline Drive. A Street Cut permit and/or Revocable Encroachment Permit shall be obtained from Washoe County Engineering and Capital Projects Division. A Grading Permit for the proposed access roadway shall be obtained from Washoe County Planning and Building Division, prior to construction.
- e. Add a Security Interest Holder's Certificate to the map if applicable.
- f. Grant 10' easements for P.U.E. snow storage and signage along North Timberline Drive and grant within the owners certificate.

Washoe County Planning and Building Division - Water Planning

4. The following conditions ns are requirements of the Planning and Building Division, Water Management Planner Coordinator, which shall be responsible for determining compliance with these conditions.

Contact: Vahid Behmaram, 775.945.4647, vbehmaram@washoecounty.us

- a. The subject parcel shall contain TMWA's note and acknowledgement regards all conditions necessary for provision of water service to these 3 parcels. Or a valid will-serve from TMWA for the 3 parcel is also acceptable.

*** End of Conditions ***



WASHOE COUNTY
COMMUNITY SERVICES DEPARTMENT
Engineering & Capital Projects

1001 EAST 9TH STREET
PO BOX 11130
RENO, NEVADA 89520-0027
PHONE (775) 328.3600
FAX (775) 328.3699

January 3, 2018

TO: Julee Olander, Planner
FROM: Timothy Simpson, P.E., Engineering Utilities
SUBJECT: WTPM17-0011 (Pardula Living Trust) Parcel 049-060-57

The Washoe County Engineering & Capital Projects Utilities Section has the following comments:

1. The applicant is proposing to divide a 9.01 acre parcel into three parcels. The parcels are located off of Timberline Drive approximately 0.4 miles north of Mt. Rose Highway.
2. There currently exists three sewer laterals to the existing parcel. Their location is based on the proposed phase two layout of White Rose Subdivision that was never completed.
3. The parcels will receive sanitary sewer service from Washoe County.
4. All parcels created by this map are subject to Washoe County Sanitary Sewer Service Ordinance upon connecting to the sewer collection system.

The Washoe County Engineering & Capital Projects Utilities Section recommends approval with the following conditions:

1. The applicant shall either dedicate an easements for the purpose of allowing parcel two (2) to construct, reconstruct, alter, repair, maintain a sanitary sewer lateral through parcel three (3), or shall have one of the laterals located on the future parcel three (3) abandoned to the satisfaction of Washoe County's Sewer Utility.



INTEGRITY



EFFECTIVE
COMMUNICATION



QUALITY
PUBLIC SERVICE



WASHOE COUNTY

Engineering & Capital Projects

INTEGRITY COMMUNICATION SERVICE

Community Services
Department
P.O. Box 11130
Reno, Nevada 89520-0027
Phone: (775) 328-3600
Fax: (775) 328-3699

INTEROFFICE MEMORANDUM

PARCEL MAP REVIEW

DATE: January 12th, 2018

TO: Department of Community Services, Chris Bronczyk, Julee Olander

FROM: Mike Gump, PLS, Engineering Division

SUBJECT: *Parcel Map for: Pardula Living Trust*
Parcel Map Case No.: WTPM17-0011
APN: 049-060-57
Review Date: 1/04/2018

The Engineering Division has reviewed the subject parcel map and the following conditions must be successfully completed prior to final approval of this application by the Engineering Division.

1. Comply with the conditions of the Washoe County technical check for this map.
2. The applicant shall submit a letter from a PLS certifying that the driveway improvements do not exceed a 14% gradient.
3. The proposed access roadway to the parcels traverse slopes 30% or greater and per Washoe County Code requires a Special Use Permit (Article 110.438.35.a.3). Prior to the recordation of the final map a Special Use Permit shall be obtained for the proposed access road or any driveway which traverses slopes 30% or greater.
4. Prior to the recordation of the final map, the access roadway shall be designed and submitted for review and approval by Washoe County and constructed. An asphalt or concrete driveway apron in accordance with Washoe County standard detail W5.2 or W5.3 shall be provided at the tie-in with Timberline Drive. A Street Cut permit and/or Revocable Encroachment Permit shall be obtained from Washoe County Engineering and Capital Projects Division. A Grading Permit for the proposed access roadway shall be obtained from Washoe County Planning and Building Division, prior to construction.
5. Add a Security Interest Holder's Certificate to the map if applicable.
6. Grant 10' easements for P.U.E. snow storage and signage along North Timberline Drive and grant within the owners certificate.

From: [Reynolds, Denise](#)
To: [Olander, Julee](#)
Subject: Todd & Manuela Pardula
Date: Thursday, January 04, 2018 3:52:08 PM
Attachments: [image001.png](#)

No comment for this either☺

Denise Reynolds
Interim Fire Marshal
Truckee Meadows Fire Protection District
1001 E. Ninth Street Bldg D Ste. 210
Reno, Nv 89512
775-326-6079
email: dreynolds@tmfpd.us





REGIONAL TRANSPORTATION COMMISSION

Metropolitan Planning • Public Transportation & Operations • Engineering & Construction

Metropolitan Planning Organization of Washoe County, Nevada

January 2, 2018

FR: Chrono/PL 183-17

Mr. Roger Pelham, Senior Planner
Community Services Department
Washoe County
PO Box 11130
Reno, NV 89520

**RE: WSUP17-0023 (Williams Residence Grading)
WSUP17-0025 (Verizon Wireless-Hidden Valley Golf Course)
WTPM17-0011 (Pardula Living Trust)
WTPM17-0025 (Fritter)**

Dear Mr. Pelham,

We have reviewed the above applications and have no comments at this time.

Thank you for the opportunity to comment on these applications. Please feel free to contact me at 775-332-0174 or email me at rkapuler@rtcwashoe.com if you have any questions or comments.

Sincerely,

Rebecca Kapuler
Planner

RK/jm

Copies: Mojra Hauenstein, Washoe County Community Services
Trevor Lloyd, Washoe County Community Services
Julee Olander, Washoe County Community Services
Chris Bronczyk, Washoe County Community Services
Eva Krause, Washoe County Community Services
Jae Pullen, Nevada Department of Transportation, District II
Daniel Doenges, Regional Transportation Commission
Tina Wu, Regional Transportation Commission
Mark Maloney, Regional Transportation Commission
Julie Masterpool, Regional Transportation Commission
David Jickling, Regional Transportation Commission

/Washoe County no comment 01052018

**WASHOE COUNTY
HEALTH DISTRICT**
ENHANCING QUALITY OF LIFE

January 8, 2018

Julie Olander, Planner
Washoe County Community Services
Planning and Development Division
PO Box 11130
Reno, NV 89520-0027

RE: Pardula; APN 049-060-57
Tentative Parcel Map; WTPM17-0011

Dear Mrs. Olander:

The Washoe County Health District, Environmental Health Services Division (WCHD) has reviewed the above referenced project. Approval by the WCHD is subject to the following conditions:

1. WCHD has reviewed the above tentative parcel map and has no objections to the approval of the project as proposed with the following conditions:
 - a. All parcels are to be serviced by municipal sewer and water.

If you have any questions or would like clarification regarding the foregoing, please contact Wes Rubio, Senior Environmental Health Specialist at wrubio@washoecounty.us regarding all Health District comments.

Sincerely,



James English, REHS, CP-FS
EHS Supervisor
Waste Management/Land Development Programs

JE:wr



WASHOE COUNTY
COMMUNITY SERVICES
INTEGRITY COMMUNICATION SERVICE

P.O. Box 11130
Reno, Nevada 89520-0027
Phone: (775) 328-3600
Fax: (775) 328-3699

December 22, 2017

TO: Julee Olander, Planner, CSD, Planning & Development Division
FROM: Vahid Behmaram, Water Management Planner Coordinator, CSD
SUBJECT: Tentative Parcel Map Case Number WTPM17-0011 (Pardula Living Trust)

Project description:

The applicant is proposing a tentative parcel map dividing one parcel of ± 9.01 acres into three parcels. The three parcels will be $\pm 52,933$ square feet (1.215 acres), ± 6.07 acres and $\pm 75,022$ square feet (1.722 acres) in size, located on Timberline Drive approximately 0.4 miles north of Mt. Rose Highway, APN 049-060-57. Water service is to be provided by the Truckee Meadows Water Authority (TMWA) and Sanitary Sewer service to be provided by Washoe County.

The Community Services Department (CSD) recommends approval of this project with the following Water Rights conditions:

- 1) The Parcel Map shall contain TMWA's note and acknowledgement regards all conditions necessary for provision of water service to these 3 parcels. Or a valid will serve from TMWA for the 3 parcel is also acceptable.

Parcel Map Application
Pardula Living Trust
Dated April 10, 1998

Submitted to Washoe County
July 17, 2017
Resubmitted December 15, 2017

Prepared for

Todd & Manuela Pardula

14230 E. Windriver Lane

Reno, NV 89511

Prepared by



WOOD RODGERS

BUILDING RELATIONSHIPS ONE PROJECT AT A TIME

1361 Corporate Blvd • Reno, NV 89502 • Tel: 775.823.4703 • www.woodrogers.com

EXHIBIT C

Washoe County Development Application

Your entire application is a public record. If you have a concern about releasing personal information, please contact Planning and Building staff at 775.328.6100.

Project Information		Staff Assigned Case No.: _____	
Project Name: Pardula Living Trust Dated April 10, 1998			
Project Description: Parcel Map to create three separate parcels.			
Project Address: 0 N. Timberline Drive, Washoe County, NV 89511			
Project Area (acres or square feet): 9.01 acres			
Project Location (with point of reference to major cross streets AND area locator): North of Mt. Rose Highway			
Assessor's Parcel No.(s):	Parcel Acreage:	Assessor's Parcel No.(s):	Parcel Acreage:
049-060-57	9.01 acres		
Section(s)/Township/Range: NW 1/4 of Section 34 Township 18 N, Range 19 E			
Indicate any previous Washoe County approvals associated with this application:			
Case No.(s). N/A			
Applicant Information (attach additional sheets if necessary)			
Property Owner:		Professional Consultant:	
Name: Todd & Manuela Pardula		Name: Wood Rodgers, Inc.	
Address: 14230 E. Windriver Lane		Address: 1361 Corporate Boulevard	
Reno, Nevada	Zip: 89511	Reno, Nevada	Zip: 89502
Phone:	Fax:	Phone: (775) 823-7742	Fax: (775) 823-4066
Email: dbigrigg@woodrodgers.com		Email: dkirkland@woodrodgers.com	
Cell:	Other:	Cell: (775) 771-0066	Other:
Contact Person: Todd Pardula		Contact Person: Derek Kirkland	
Applicant/Developer:		Other Persons to be Contacted:	
Name: Same As Above		Name: Wood Rodgers, Inc.	
Address:		Address: 1361 Corporate Boulevard	
	Zip:	Reno, Nevada	Zip: 89502
Phone:	Fax:	Phone: (775) 853-7453	Fax: (775) 823-4066
Email:		Email: dbigrigg@woodrodgers.com	
Cell:	Other:	Cell: (775) 745-1493	Other:
Contact Person:		Contact Person: Dan Bigrigg	
For Office Use Only			
Date Received:	Initial:	Planning Area:	
County Commission District:		Master Plan Designation(s):	
CAB(s):		Regulatory Zoning(s):	

Property Owner Affidavit

Applicant Name: Todd Pardula

The receipt of this application at the time of submittal does not guarantee the application complies with all requirements of the Washoe County Development Code, the Washoe County Master Plan or the applicable area plan, the applicable regulatory zoning, or that the application is deemed complete and will be processed.

STATE OF NEVADA)
COUNTY OF WASHOE)

I, Todd Pardula
(please print name)

being duly sworn, depose and say that I am the owner* of the property or properties involved in this application as listed below and that the foregoing statements and answers herein contained and the information herewith submitted are in all respects complete, true and correct to the best of my knowledge and belief. I understand that no assurance or guarantee can be given by members of Planning and Development.

(A separate Affidavit must be provided by each property owner named in the title report.)

Assessor Parcel Number(s): 049-060-57

Printed Name Todd Pardula

Signed Todd Pardula

Address 14230 E Windriver Ln
Reno NV 89511

Subscribed and sworn to before me this 14th day of June, 2017

Michelle Antonowicz
Notary Public in and for said county and state

My commission expires: 06-01-2021

(Notary Stamp)

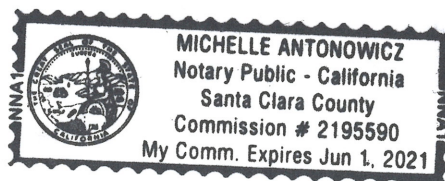

*Owner refers to the following: (Please mark appropriate box.)

- Owner
- Corporate Officer/Partner (Provide copy of recorded document indicating authority to sign.)
- Power of Attorney (Provide copy of Power of Attorney.)
- Owner Agent (Provide notarized letter from property owner giving legal authority to agent.)
- Property Agent (Provide copy of record document indicating authority to sign.)
- Letter from Government Agency with Stewardship

Property Owner Affidavit

Applicant Name: Manuela Pardula

The receipt of this application at the time of submittal does not guarantee the application complies with all requirements of the Washoe County Development Code, the Washoe County Master Plan or the applicable area plan, the applicable regulatory zoning, or that the application is deemed complete and will be processed.

Calif.
STATE OF ~~NEVADA~~)
Santa Clara)
COUNTY OF ~~WASHOE~~)

I, Manuela Pardula
(please print name)

being duly sworn, depose and say that I am the owner* of the property or properties involved in this application as listed below and that the foregoing statements and answers herein contained and the information herewith submitted are in all respects complete, true and correct to the best of my knowledge and belief. I understand that no assurance or guarantee can be given by members of Planning and Development.

(A separate Affidavit must be provided by each property owner named in the title report.)

Assessor Parcel Number(s): 049-060-57

Printed Name Manuela Pardula

Signed [Signature]

Address 14230 E Windriver Ln
Reno NV 89511

Subscribed and sworn to before me this 14th day of June, 2017

[Signature]
Notary Public in and for said county and state

My commission expires: 06-01-2021

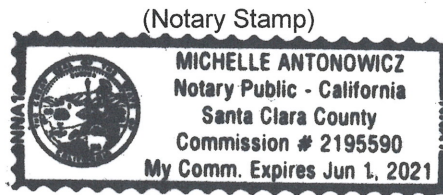

*Owner refers to the following: (Please mark appropriate box.)

- Owner
- Corporate Officer/Partner (Provide copy of recorded document indicating authority to sign.)
- Power of Attorney (Provide copy of Power of Attorney.)
- Owner Agent (Provide notarized letter from property owner giving legal authority to agent.)
- Property Agent (Provide copy of record document indicating authority to sign.)
- Letter from Government Agency with Stewardship

Tentative Parcel Map Application Supplemental Information

(All required information may be separately attached)

Chapter 110 of the Washoe County Code is commonly known as the Development Code. Specific references to tentative parcel maps may be found in Article 606, Parcel Maps.

1. What is the location (address or distance and direction from nearest intersection)?

0 N. Timberline Drive, Washoe County, Nevada 89511, North of Mt. Rose Highway.

- a. Please list the following:

APN of Parcel	Land Use Designation	Existing Acres
049-060-57	Vacant Single Family	9.01 ac

2. Please describe the existing conditions, structures, and uses located at the site:

Vacant Undeveloped Land

3. What are the proposed lot standards?

	Parcel 1	Parcel 2	Parcel 3	Parcel 4
Minimum Lot Area	52,933 sf	6.07 ac	75,022 sf	
Minimum Lot Width	120 feet	120 feet	120 feet	

4. Was the parcel or lot that is proposed for division created (recorded) within the last 5 years? (If yes, public review of the parcel map will be required. See Planning and Building staff for additional materials that are required to be submitted.)

<input type="checkbox"/> Yes	<input checked="" type="checkbox"/> No
------------------------------	--

5. Utilities:

a. Sewer Service	3 stubs located in Timberline Drive
b. Electrical Service/Generator	Existing Service
c. Water Service	3 stubs located in Timberline Drive

6. Please describe the source of the water facilities necessary to serve the proposed tentative parcel map:

- a. Water System Type:

<input type="checkbox"/> Individual wells		
<input type="checkbox"/> Private water	Provider:	
<input checked="" type="checkbox"/> Public water	Provider:	TMWA

- b. Available:

<input checked="" type="checkbox"/> Now	<input type="checkbox"/> 1-3 years	<input type="checkbox"/> 3-5 years	<input type="checkbox"/> 5+ years
---	------------------------------------	------------------------------------	-----------------------------------

- c. Washoe County Capital Improvements Program project?

<input type="checkbox"/> Yes	<input checked="" type="checkbox"/> No
------------------------------	--

7. What sewer services are necessary to accommodate the proposed tentative parcel map?

- a. Sewage System Type:

<input type="checkbox"/> Individual septic		
<input checked="" type="checkbox"/> Public system	Provider:	Washoe County

- b. Available:

<input checked="" type="checkbox"/> Now	<input type="checkbox"/> 1-3 years	<input type="checkbox"/> 3-5 years	<input type="checkbox"/> 5+ years
---	------------------------------------	------------------------------------	-----------------------------------

- c. Washoe County Capital Improvements Program project?

<input type="checkbox"/> Yes	<input checked="" type="checkbox"/> No
------------------------------	--

8. For most uses, the Washoe County Code, Chapter 110, Article 422, Water and Sewer Resource Requirements, requires the dedication of water rights to Washoe County when creating new parcels. Please indicate the type and quantity of water rights you have available should dedication be required:

a. Permit #		acre-feet per year	
b. Certificate #		acre-feet per year	
c. Surface Claim #		acre-feet per year	
d. Other, #		acre-feet per year	

- e. Title of those rights (as filed with the State Engineer in the Division of Water Resources of the Department of Conservation and Natural Resources):

Water rights for this property are currently in process to be purchased.

9. Does the property contain wetlands? (If yes, please attach a preliminary delineation map and describe the impact the proposal will have on the wetlands. Impacts to the wetlands may require a permit issued from the U.S. Army Corps of Engineers.)

<input type="checkbox"/> Yes	<input checked="" type="checkbox"/> No	If yes, include a separate set of attachments and maps.
------------------------------	--	---

10. Does property contain slopes or hillsides in excess of 15 percent and/or significant ridgelines? (If yes, and this is the second parcel map dividing this property, Article 424, Hillside Development of the Washoe County Development Code will apply.)

<input checked="" type="checkbox"/> Yes	<input type="checkbox"/> No	If yes, include a separate set of attachments and maps.
---	-----------------------------	---

11. Does property contain geologic hazards such as active faults; hillside or mountainous areas; is it subject to avalanches, landslides, or flash floods; is it near a water body, stream, Significant Hydrologic Resource as defined in Article 418, or riparian area such as the Truckee River, and/or an area of groundwater recharge

<input checked="" type="checkbox"/> Yes	<input type="checkbox"/> No	If yes, include a separate set of attachments and maps.
---	-----------------------------	---

12. Does the tentative parcel map involve common open space as defined in Article 408 of the Washoe County Development Code? (If so, please identify all proposed non-residential uses and all the open space parcels.)?

<input type="checkbox"/> Yes	<input checked="" type="checkbox"/> No	If yes, include a separate set of attachments and maps.
------------------------------	--	---

13. If private roads are proposed, will the community be gated? If so, is a public trail system easement provided through the subdivision?

N/A

14. Are there any applicable policies of the adopted area plan in which the project is located that require compliance? If so, which policies and how does the project comply

<input type="checkbox"/> Yes	<input checked="" type="checkbox"/> No	If yes, include a separate set of attachments and maps.
------------------------------	--	---

15. Are there any applicable area plan modifiers in the Development Code in which the project is located that require compliance? If so, which modifiers and how does the project comply?

No

16. Is the project subject to Article 418, Significant Hydrologic Resources? If yes, please address Special Review Considerations within Section 110.418.30 in a separate attachment.

<input type="checkbox"/> Yes	<input checked="" type="checkbox"/> No	If yes, include a separate set of attachments and maps.
------------------------------	--	---

Grading

Please complete the following additional questions if the project anticipates grading that involves: (1) Disturbed area exceeding twenty-five thousand (25,000) square feet not covered by streets, buildings and landscaping; (2) More than one thousand (1,000) cubic yards of earth to be imported and placed as fill in a special flood hazard area; (3) More than five thousand (5,000) cubic yards of earth to be imported and placed as fill; (4) More than one thousand (1,000) cubic yards to be excavated, whether or not the earth will be exported from the property; or (5) If a permanent earthen structure will be established over four and one-half (4.5) feet high. If your project exceeds any of the above criteria, you shall either provide a preliminary grading and roadway design plan for review OR if these criteria are exceeded with the final construction drawings and not disclosed at the Tentative Parcel Map Application, you shall be required to apply for a special use permit for grading and you will be delayed up to three months, if approved.

17. How many cubic yards of material are you proposing to excavate on site?

Only the parcel map is being completed there is no grading anticipated at this time.
--

18. How many cubic yards of material are you exporting or importing? If exporting of material is anticipated, where will the material be sent? If the disposal site is within unincorporated Washoe County, what measures will be taken for erosion control and revegetation at the site? If none, how are you balancing the work on-site?

N/A

19. Can the disturbed area be seen from off-site? If yes, from which directions, and which properties or roadways? What measures will be taken to mitigate their impacts?

N/A

20. What is the slope (Horizontal/Vertical) of the cut and fill areas proposed to be? What methods will be used to prevent erosion until the revegetation is established?

N/A

21. Are you planning any berms and, if so, how tall is the berm at its highest? How will it be stabilized and/or revegetated?

N/A

22. Are retaining walls going to be required? If so, how high will the walls be, will there be multiple walls with intervening terracing, and what is the wall construction (i.e. rockery, concrete, timber, manufactured block)? How will the visual impacts be mitigated?

N/A

23. Will the grading proposed require removal of any trees? If so, what species, how many, and of what size?

N/A

24. What type of revegetation seed mix are you planning to use and how many pounds per acre do you intend to broadcast? Will you use mulch and, if so, what type?

N/A

25. How are you providing temporary irrigation to the disturbed area?

N/A

26. Have you reviewed the revegetation plan with the Washoe Storey Conservation District? If yes, have you incorporated their suggestions?

N/A

27. Surveyor:

Name	Wood Rodgers, Inc. (Dan Bigrigg)
Address	1361 Corporate Boulevard, Reno, NV 89502
Phone	(775) 853-7453
Cell	(775) 745-1493
E-mail	dbigrigg@woodroddgers.com
Fax	(775) 823-4066
Nevada PLS #	19716

Account Detail

[Back to Account Detail](#)

[Change of Address](#)

[Print this Page](#)

Washoe County Parcel Information

Parcel ID	Status	Last Update
04906057	Active	12/14/2017 2:10:50 AM

Current Owner:
 PARDULA LIVING TRUST

 14230 E WINDRIVER LN
 RENO, NV 89511

SITUS:
 0 N TIMBERLINE DR
 WCTY NV

Taxing District

Geo CD:

Legal Description

SubdivisionName _UNSPECIFIED Block Section Township 18 Lot B Range 19

Tax Bill (Click on desired tax year for due dates and further details)

Tax Year	Net Tax	Total Paid	Penalty/Fees	Interest	Balance Due
2017	\$2,165.78	\$2,165.78	\$0.00	\$0.00	\$0.00
2016	\$2,112.56	\$2,112.56	\$0.00	\$0.00	\$0.00
2015	\$2,107.07	\$2,107.07	\$0.00	\$0.00	\$0.00
2014	\$2,041.34	\$2,041.34	\$0.00	\$0.00	\$0.00
2013	\$2,041.74	\$2,041.74	\$0.00	\$0.00	\$0.00
Total					\$0.00

Important Payment Information

- **ALERTS:** If your real property taxes are delinquent, the search results displayed may not reflect the correct amount owing. Please contact our office for the current amount due.
- For your convenience, online payment is available on this site. E-check payments are accepted without a fee. However, a service fee does apply for online credit card payments. See Payment Information for details.

Pay Online

No payment due for this account.

\$0.00

Pay By Check

Please make checks payable to:
 WASHOE COUNTY TREASURER

Mailing Address:
 P.O. Box 30039
 Reno, NV 89520-3039

Overnight Address:
 1001 E. Ninth St., Ste D140
 Reno, NV 89512-2845



The Washoe County Treasurer's Office makes every effort to produce and publish the most current and accurate information possible. No warranties, expressed or implied, are provided for the data herein, its use, or its interpretation. If you have any questions, please contact us at (775) 328-2510 or tax@washoecounty.us

This site is best viewed using Google Chrome, Internet Explorer 11, Mozilla Firefox or Safari.

BASIS OF BEARINGS:

WASHE COUNTY PLAT COMPASS SYSTEM WEST WASH STATE (MAD 83/94-HARR) AS DETERMINED USING REAL TIME KINEMATIC NETWORK (RTK) COUNTY CONTINUOUSLY OPERATING REFERENCE STATIONS (CORS) W ZOLEZZI - SRESM0179 AND "RNM RENOV" - WYASW01028. THE BEARING OF THE WASH STATE ZOLEZZI STATION AS SHOWN ON THE PLAT DIMENSIONS SHOWN ARE GROUND DISTANCES. COMBINED GRID TO GROUND FACTOR = 1.000197938.



LEGEND:

- FOUND 5/8\"/>
- FOUND 5/8\"/>
- FOUND COPPER NAIL IN MONUMENT WELL CENTERLINE MONUMENT
- SET 5/8\"/>
- WASHE COUNTY CORS REFERENCE STATION
- PLAT CORNERS
- DIMENSION POINT, NOTHING FOUND OR SET
- RECORD DIMENSION AND REFERENCE NUMBER
- PARCEL MAP
- TRACT MAP
- GRAPHIC BOUNDARY
- PARCEL LINE
- ADJACENT PARCEL
- SEWER LINE
- EASEMENT AS NOTED
- EASEMENT AS NOTED

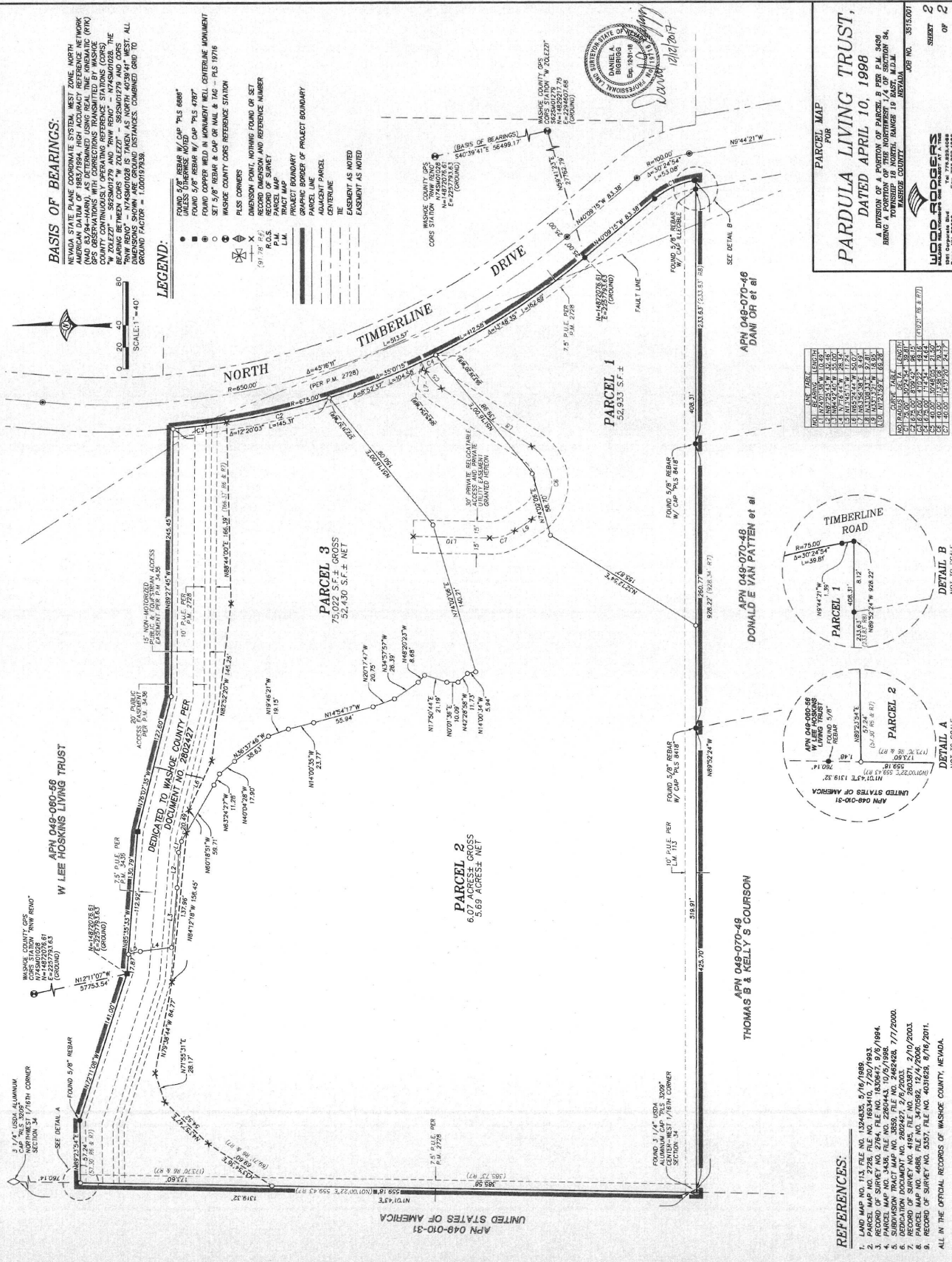

PARCEL MAP FOR
PARDULA LIVING TRUST,
DATED APRIL 10, 1998
 A DIVISION OF A PORTION OF PARCEL B PER P.M. 3498
 BEING A PORTION OF PARCEL B PER P.M. 3498
 TOWNSHIP 18 NORTH, RANGE 10 EAST, COUNTY 94,
 WASHOE COUNTY, NEVADA. REF. NO. 3515001
WOOD ROGERS
 REALTY CORPORATION
 1000 W. WASHINGTON
 SUITE 100, LAS VEGAS, NV 89102
 PHONE: 702.735.8888
 FAX: 702.735.8888
 SHEET **2** OF **2**

NO.	AREA	LENGTH	WIDTH	AREA
1	1.00	100.00	100.00	10000.00
2	1.00	100.00	100.00	10000.00
3	1.00	100.00	100.00	10000.00
4	1.00	100.00	100.00	10000.00
5	1.00	100.00	100.00	10000.00
6	1.00	100.00	100.00	10000.00
7	1.00	100.00	100.00	10000.00
8	1.00	100.00	100.00	10000.00
9	1.00	100.00	100.00	10000.00
10	1.00	100.00	100.00	10000.00
11	1.00	100.00	100.00	10000.00
12	1.00	100.00	100.00	10000.00
13	1.00	100.00	100.00	10000.00
14	1.00	100.00	100.00	10000.00
15	1.00	100.00	100.00	10000.00
16	1.00	100.00	100.00	10000.00
17	1.00	100.00	100.00	10000.00
18	1.00	100.00	100.00	10000.00
19	1.00	100.00	100.00	10000.00
20	1.00	100.00	100.00	10000.00
21	1.00	100.00	100.00	10000.00
22	1.00	100.00	100.00	10000.00
23	1.00	100.00	100.00	10000.00
24	1.00	100.00	100.00	10000.00
25	1.00	100.00	100.00	10000.00
26	1.00	100.00	100.00	10000.00
27	1.00	100.00	100.00	10000.00
28	1.00	100.00	100.00	10000.00
29	1.00	100.00	100.00	10000.00
30	1.00	100.00	100.00	10000.00
31	1.00	100.00	100.00	10000.00
32	1.00	100.00	100.00	10000.00
33	1.00	100.00	100.00	10000.00
34	1.00	100.00	100.00	10000.00
35	1.00	100.00	100.00	10000.00
36	1.00	100.00	100.00	10000.00
37	1.00	100.00	100.00	10000.00
38	1.00	100.00	100.00	10000.00
39	1.00	100.00	100.00	10000.00
40	1.00	100.00	100.00	10000.00
41	1.00	100.00	100.00	10000.00
42	1.00	100.00	100.00	10000.00
43	1.00	100.00	100.00	10000.00
44	1.00	100.00	100.00	10000.00
45	1.00	100.00	100.00	10000.00
46	1.00	100.00	100.00	10000.00
47	1.00	100.00	100.00	10000.00
48	1.00	100.00	100.00	10000.00
49	1.00	100.00	100.00	10000.00
50	1.00	100.00	100.00	10000.00
51	1.00	100.00	100.00	10000.00
52	1.00	100.00	100.00	10000.00
53	1.00	100.00	100.00	10000.00
54	1.00	100.00	100.00	10000.00
55	1.00	100.00	100.00	10000.00
56	1.00	100.00	100.00	10000.00
57	1.00	100.00	100.00	10000.00
58	1.00	100.00	100.00	10000.00
59	1.00	100.00	100.00	10000.00
60	1.00	100.00	100.00	10000.00
61	1.00	100.00	100.00	10000.00
62	1.00	100.00	100.00	10000.00
63	1.00	100.00	100.00	10000.00
64	1.00	100.00	100.00	10000.00
65	1.00	100.00	100.00	10000.00
66	1.00	100.00	100.00	10000.00
67	1.00	100.00	100.00	10000.00
68	1.00	100.00	100.00	10000.00
69	1.00	100.00	100.00	10000.00
70	1.00	100.00	100.00	10000.00
71	1.00	100.00	100.00	10000.00
72	1.00	100.00	100.00	10000.00
73	1.00	100.00	100.00	10000.00
74	1.00	100.00	100.00	10000.00
75	1.00	100.00	100.00	10000.00
76	1.00	100.00	100.00	10000.00
77	1.00	100.00	100.00	10000.00
78	1.00	100.00	100.00	10000.00
79	1.00	100.00	100.00	10000.00
80	1.00	100.00	100.00	10000.00

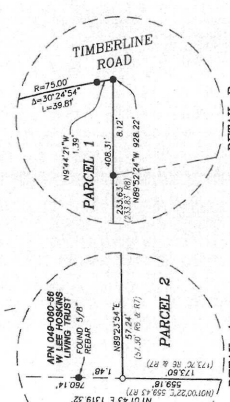

REFERENCES:

1. LAND MAP NO. 115, FILE NO. 183435, 6/16/1988
 2. PARCEL MAP NO. 2728, FILE NO. 183410, 7/20/1993
 3. RECORD OF SURVEY NO. 2784, FILE NO. 183961, 9/6/1994
 4. SURVEY MAP TRACT MAP NO. 1855, FILE NO. 01460428, 7/17/2000
 5. SURVEY MAP TRACT MAP NO. 1855, FILE NO. 01460428, 7/17/2000
 6. DEDICATION DOCUMENT NO. 2802427, 2/6/2003
 7. RECORD OF SURVEY NO. 4158, FILE NO. 2803971, 2/20/2003
 8. RECORD OF SURVEY NO. 4158, FILE NO. 2803971, 2/20/2003
 9. RECORD OF SURVEY NO. 5357, FILE NO. 4031623, 8/16/2011.
- ALL IN THE OFFICIAL RECORDS OF WASHOE COUNTY, NEVADA.

\\s155\projects\170011\170011.dwg (17/07/2017 1:14 PM) 8/9/99



VICINITY MAP
 PARDULA PARCEL
 WASHOE COUNTY, NV
 JULY, 2017
 NOTES

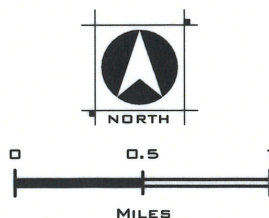

WOOD RODGERS
 BUILDING RELATIONSHIPS ONE PROJECT AT A TIME
 1361 Corporate Boulevard
 Reno, NV 89502
 Tel: 775.823.4068
 Fax: 775.823.4066

WTPM17-0011
EXHIBIT C



Source: Esri, DigitalGlobe, GeoEye, Earthstar Geographics, CNES/Airbus DS, USDA, USGS, AeroGRID, IGN, and the GIS User Community

SITE MAP
 PARDULA PARCEL
 WASHOE COUNTY, NV
 JULY, 2017
 NOTES

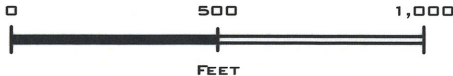

WOOD RODGERS
 BUILDING RELATIONSHIPS ONE PROJECT AT A TIME
 1361 Corporate Boulevard Tel: 775.823.4068
 Reno, NV 89502 Fax: 775.823.4066

WTPM17-0011
EXHIBIT C

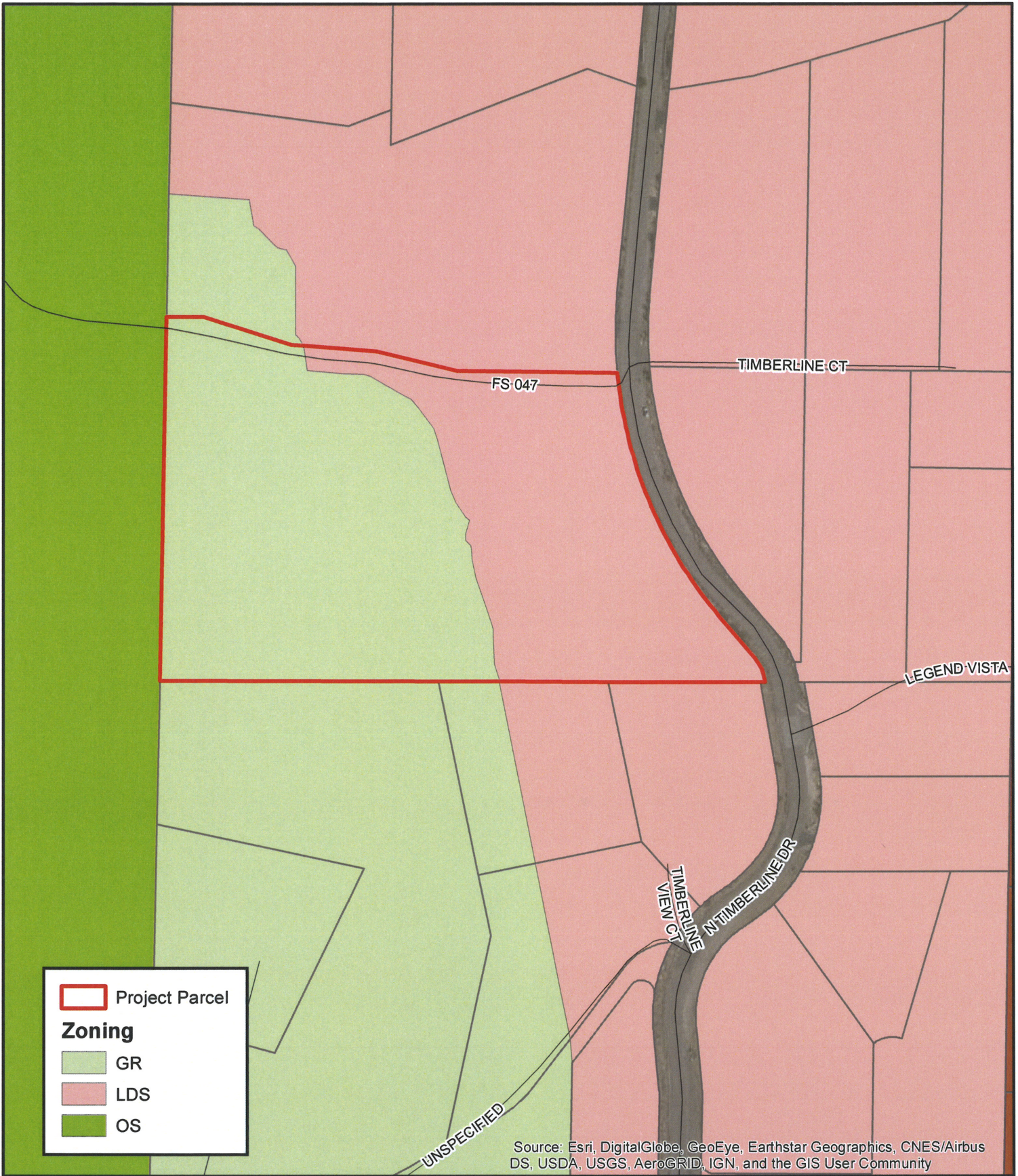

ZONING
PARDULA PARCEL
WASHOE COUNTY, NV
JULY, 2017
 NOTES

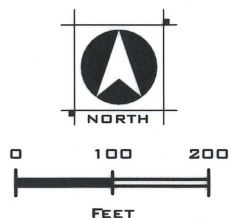

WOOD ROGERS
 BUILDING RELATIONSHIPS ONE PROJECT AT A TIME
 1361 Corporate Boulevard Tel: 775.823.4068
 Reno, NV 89502 Fax: 775.823.4066

WTPM17-0011
EXHIBIT C

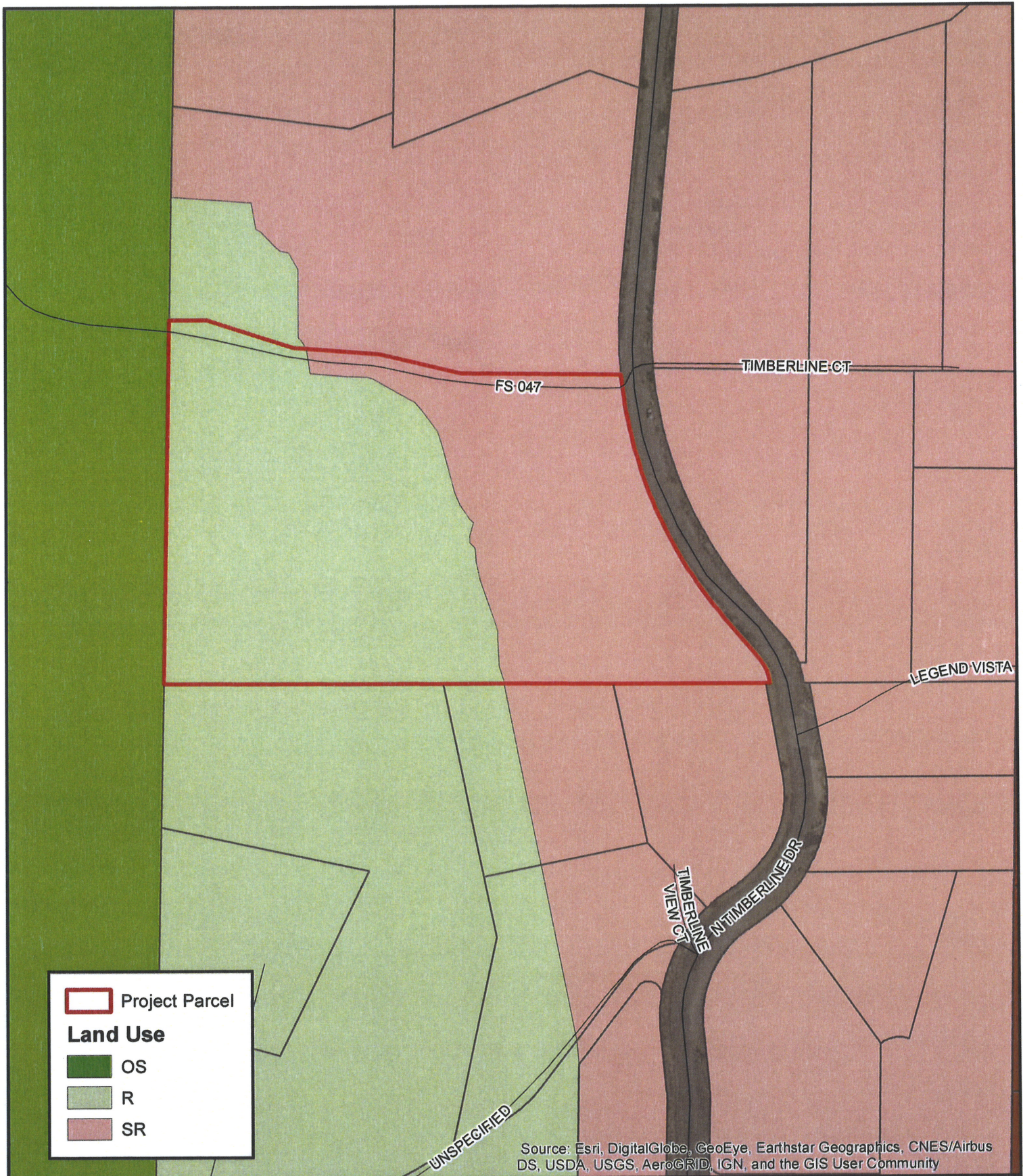

Project Parcel

Land Use

- OS
- R
- SR

Source: Esri, DigitalGlobe, GeoEye, Earthstar Geographics, CNES/Airbus DS, USDA, USGS, AeroGRID, IGN, and the GIS User Community

LAND USE
PARDULA PARCEL
WASHOE COUNTY, NV
JULY, 2017
 NOTES

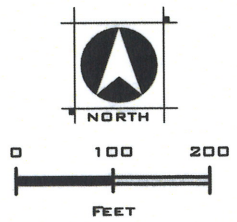



WOOD RODGERS
 BUILDING RELATIONSHIPS ONE PROJECT AT A TIME
 1361 Corporate Boulevard Tel: 775.823.4068
 Reno, NV 89502 Fax: 775.823.4066

WTPM17-0011

EXHIBIT C

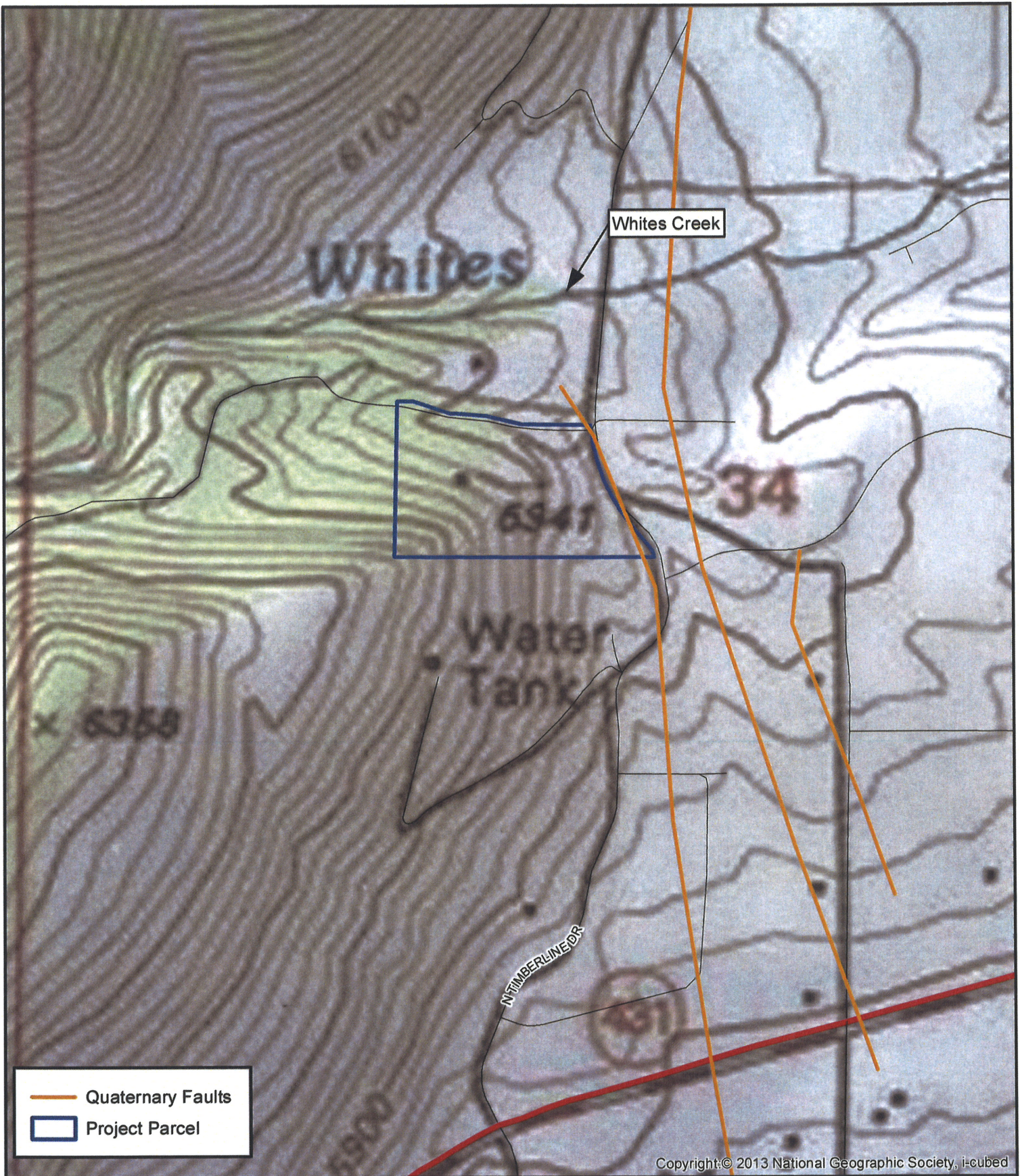

Quaternary Faults
 Project Parcel

Copyright: © 2013 National Geographic Society, i-cubed

HAZARD MAP
PARDULA PARCEL
WASHOE COUNTY, NV
JULY, 2017

NOTES

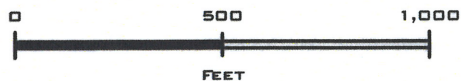
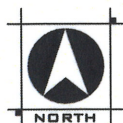

WOOD RODGERS
 BUILDING RELATIONSHIPS ONE PROJECT AT A TIME
 1361 Corporate Boulevard
 Reno, NV 89502
 Tel: 775.823.4066
 Fax: 775.823.4066

WTPM17-0011

EXHIBIT C

SLOPE MAP
 PARDULA
 RENO, NV
 JULY, 2017



Slope (%)	Area (ac.)	% of Total
0-15	2.4	26.3
15.1-20	1.2	12.8
20.1-25	1.0	10.7
25.1-30	0.9	9.6
30+	3.7	40.6
TOTAL	9	100

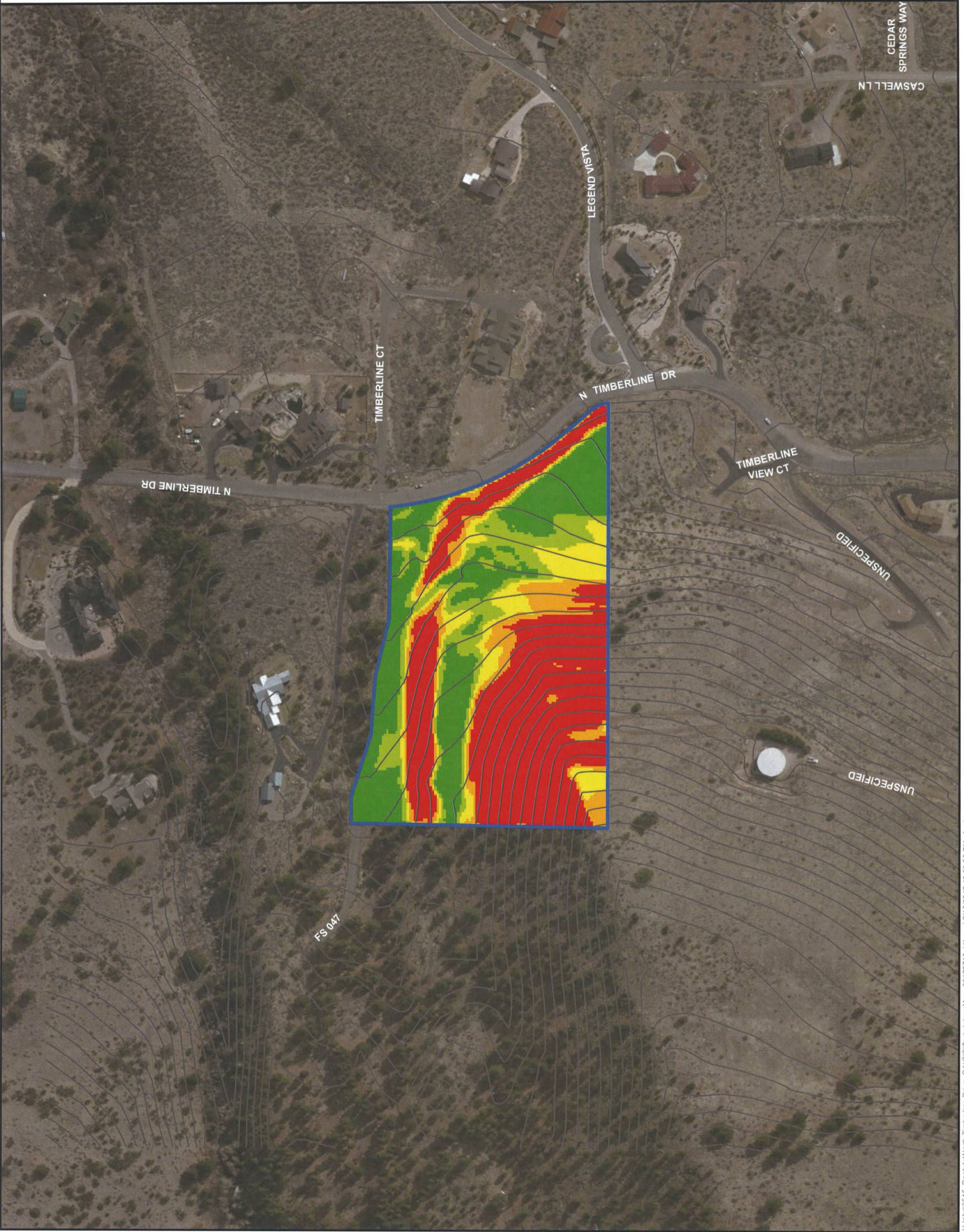

Service Layer Credits: Source: Esri, DigitalGlobe, GeoEye, Earthstar Geographics, CNES/Airbus DS, USDA, USGS, AeroGRID, IGN, and the GIS User Community

PRELIMINARY



WOOD RODGERS

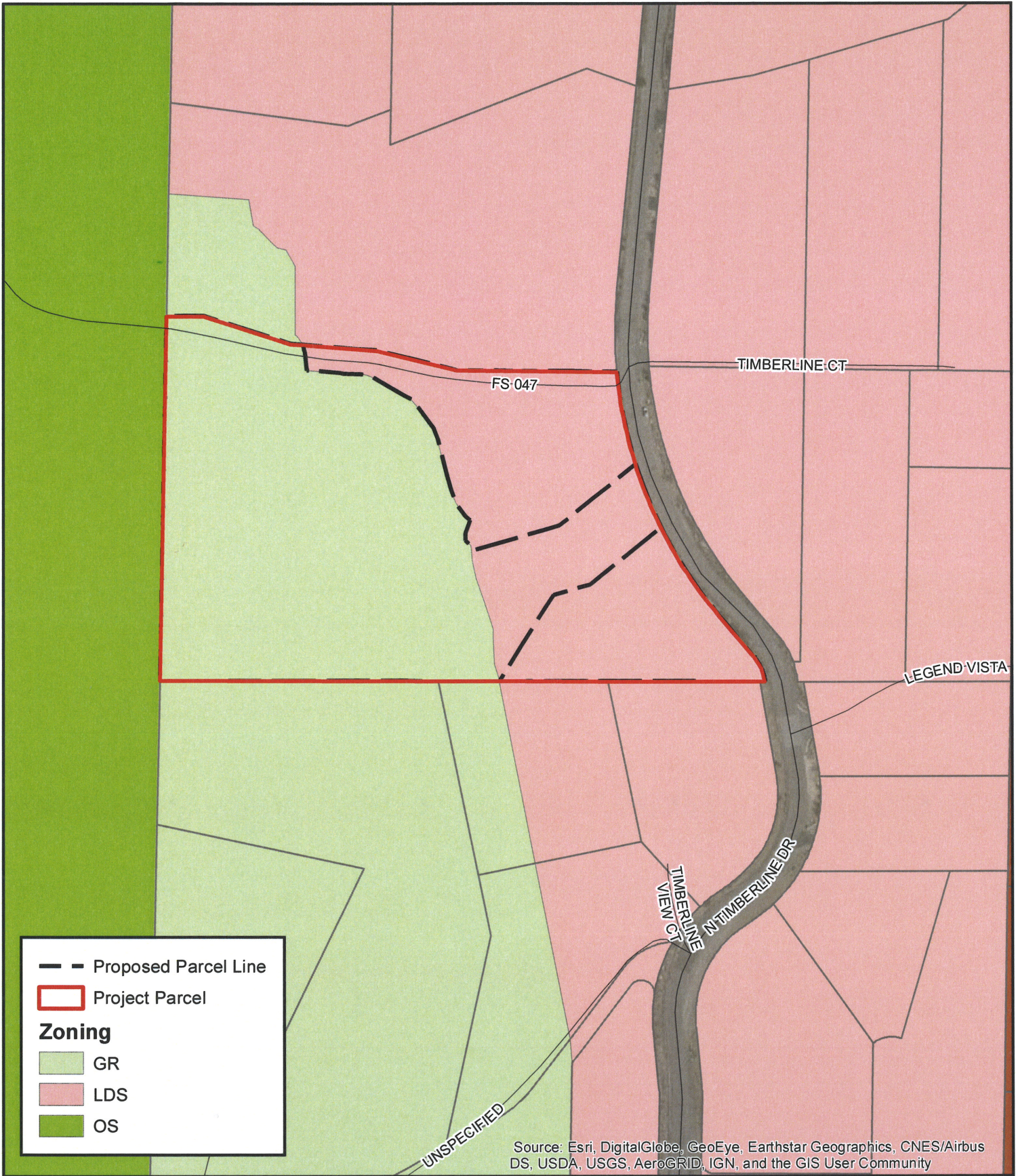

- - - Proposed Parcel Line
 Project Parcel
Zoning
 GR
 LDS
 OS

ZONING WITH PROPOSED PARCEL LINES
PARDULA PARCEL
WASHOE COUNTY, NV
JULY, 2017
 NOTES

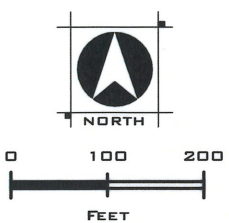

WOOD RODGERS
 BUILDING RELATIONSHIPS ONE PROJECT AT A TIME
 1361 Corporate Boulevard
 Reno, NV 89502
 Tel: 775.823.4068
 Fax: 775.823.4066

WTPM17-0011
EXHIBIT C

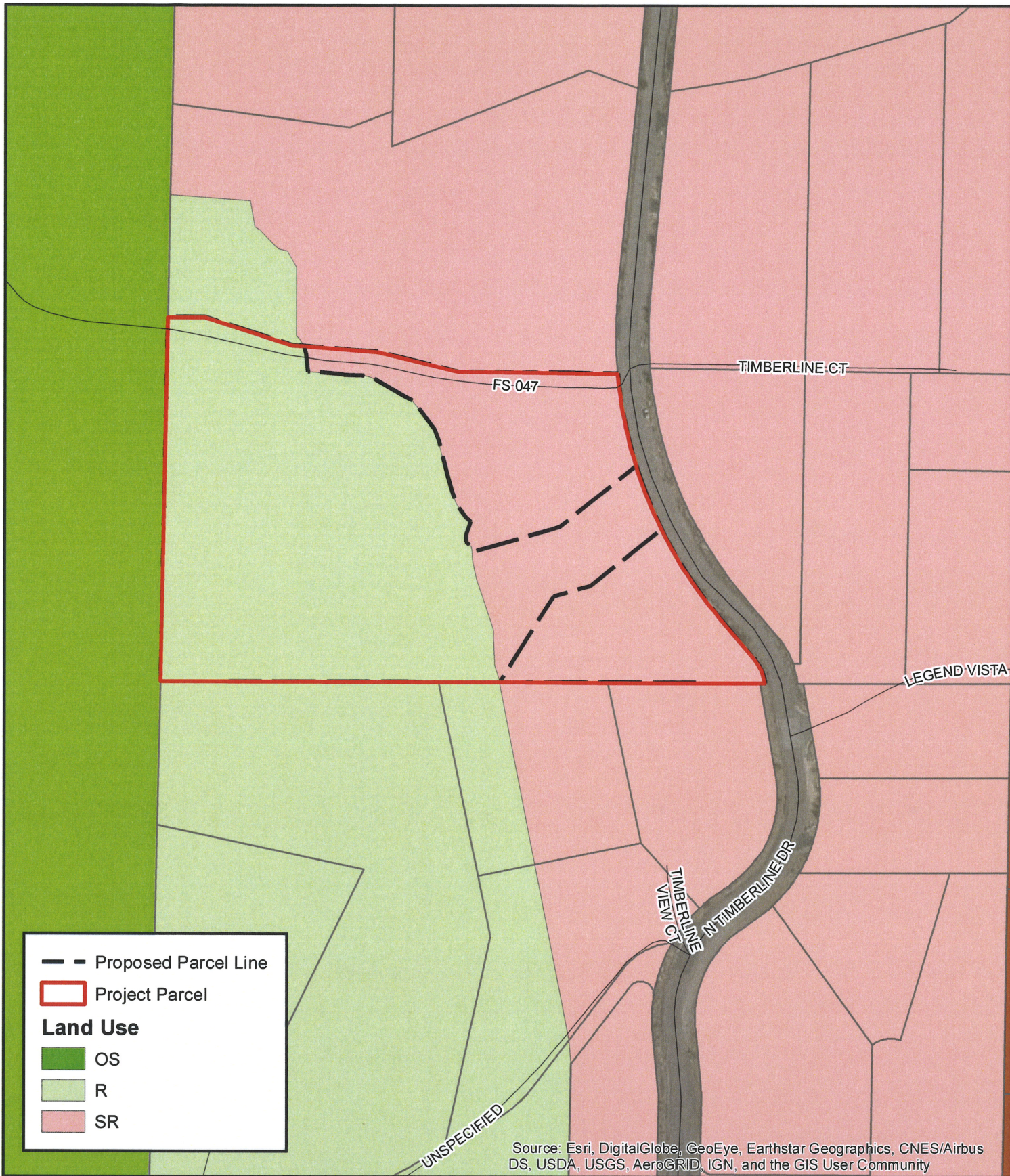

Source: Esri, DigitalGlobe, GeoEye, Earthstar Geographics, CNES/Airbus DS, USDA, USGS, AeroGRID, IGN, and the GIS User Community

LAND USE WITH PROPOSED PARCEL LINES
PARDULA PARCEL
WASHOE COUNTY, NV
JULY, 2017

NOTES

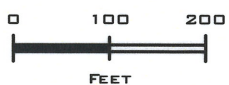

WOOD RODGERS
 BUILDING RELATIONSHIPS ONE PROJECT AT A TIME
 1361 Corporate Boulevard
 Reno, NV 89502
 Tel: 775.823.4066
 Fax: 775.823.4066

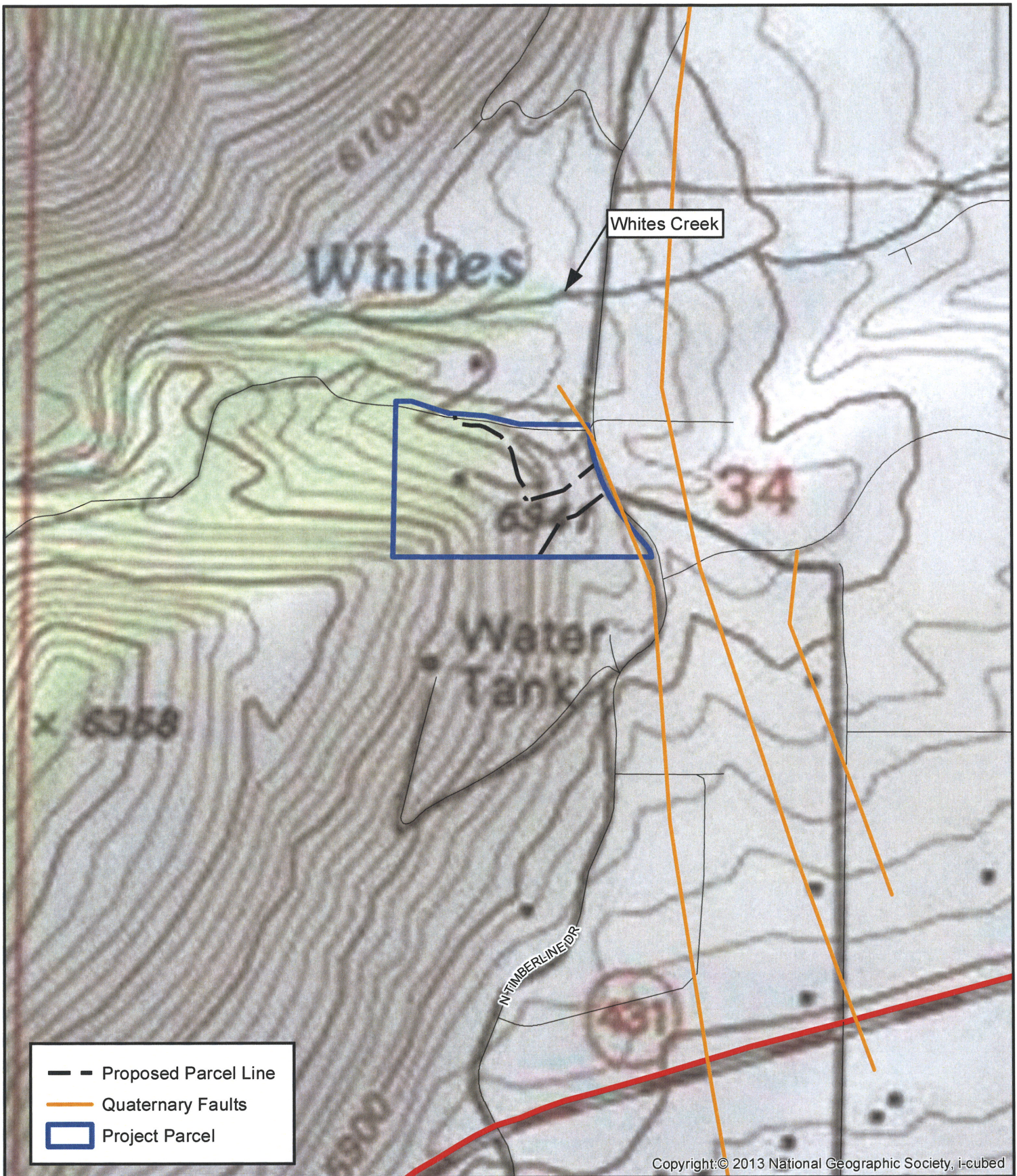

HAZARD MAP WITH PROPOSED PARCEL LINES
 PARDULA PARCEL
 WASHOE COUNTY, NV
 JULY, 2017
 NOTES

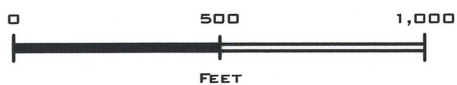

WOOD RODGERS
 BUILDING RELATIONSHIPS ONE PROJECT AT A TIME
 1361 Corporate Boulevard Reno, NV 89502
 Tel: 775.823.4068 Fax: 775.823.4066

WTPM17-0011
EXHIBIT C

SLOPE MAP
 PARDULA
 RENO, NV
 JULY, 2017

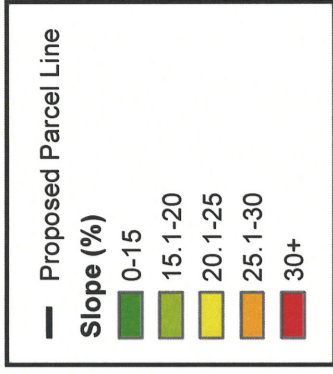
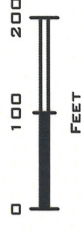
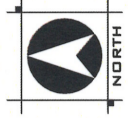

Slope (%)	Area (ac.)	% of Total
0-15	2.4	26.3
15.1-20	1.2	12.8
20.1-25	1.0	10.7
25.1-30	0.9	9.6
30+	3.7	40.6
TOTAL	9	100

Service Layer Credits: Source: Esri,
 DigitalGlobe, GeoEye, Earthstar
 Geographics, CNES/Airbus DS, USDA,
 USGS, AeroGRID, IGN, and the GIS
 User Community

PRELIMINARY



WOOD RODGERS

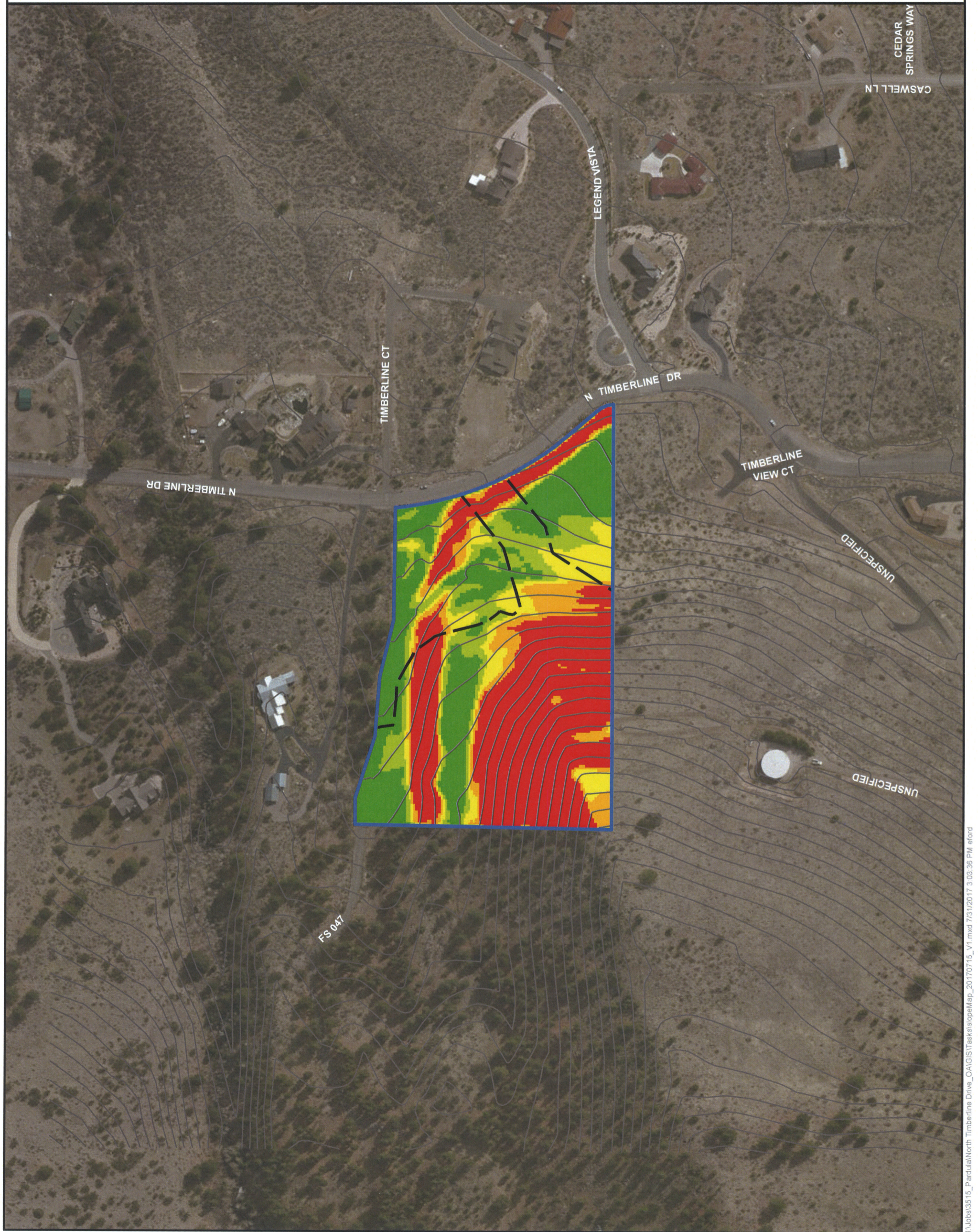

J:\Jobs\3515_Pardula\North Timberline Drive_OA\GIS\Task\islope\map_20170715_V1.mxd 7/31/2017 3:03:36 PM eford

PRELIMINARY GRADING AND SITE PLAN PARDULA PROPERTY ACCESS ROAD

WASHOE COUNTY, NEVADA
DECEMBER, 2017

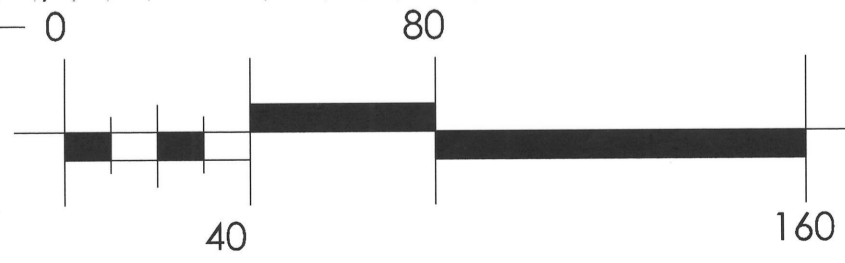
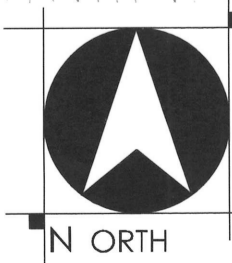
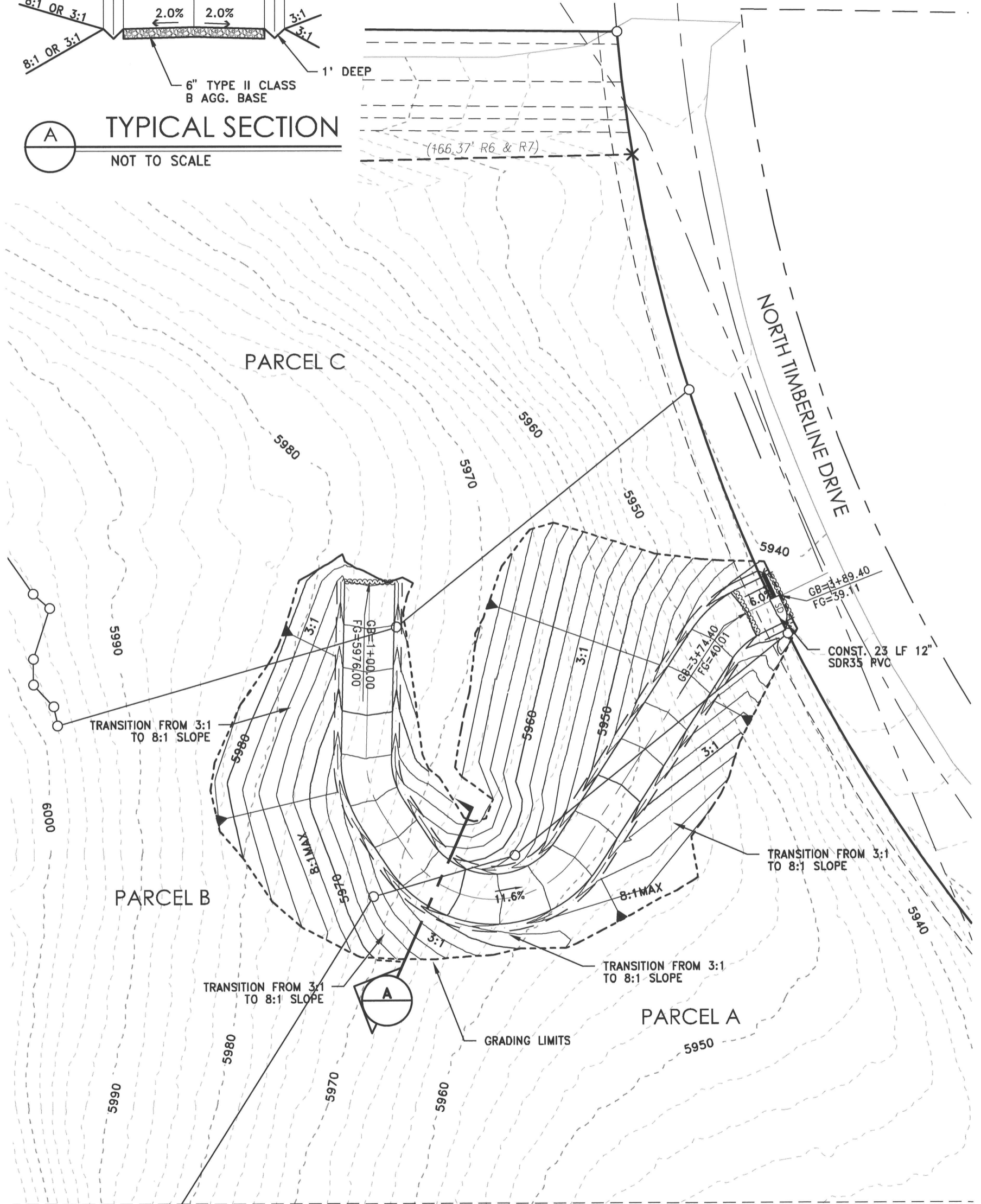
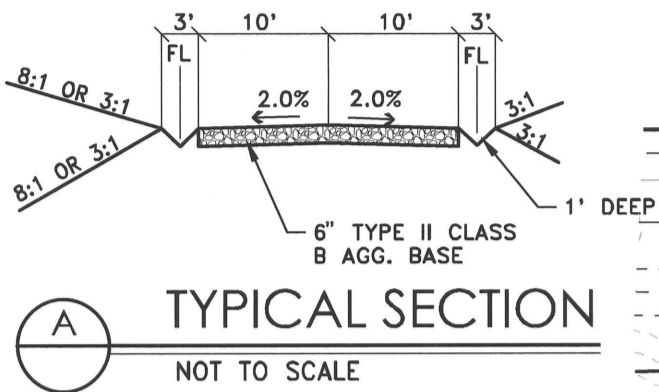

WOOD RODGERS
BUILDING RELATIONSHIPS ONE PROJECT AT A TIME
1961 Corporate Blvd
Reno, NV 89502
Tel 775.823.4068
Fax 775.823.4066

J:\Jobs\3515_Pardula\North Timberline Drive_OA\Planning\Exhibits\EXH_GRAD_SITE_PLAN_PM.dwg 12/12/2017 12:45 PM Megan Sulezich